

Yealink SIP-T48G IP Phone

User Guide



CE Mark Warning

This device is marked with the CE mark in compliance with EC Directives 2014/35/EU and 2014/30/EU.

Part 15 FCC Rules

Any Changes or modifications not expressly approved by the party responsible for compliance could void the user's authority to operate the equipment.

This device complies with Part 15 of the FCC Rules. Operation is subject to the following two conditions:

1. This device may not cause harmful interference, and
2. This device must accept any interference received, including interference that may cause undesired operation.

Class B Digital Device or Peripheral

Note: This device is tested and complies with the limits for a Class B digital device, pursuant to Part 15 of the FCC Rules. These limits are designed to provide reasonable protection against harmful interference in a residential installation. This equipment generates, uses, and can radiate radio frequency energy and, if not installed and used in accordance with the instructions, may cause harmful interference to radio communications. However, there is no guarantee that interference will not occur in a particular installation. If this equipment does cause harmful interference to radio or television reception, which can be determined by turning the equipment off and on, the user is encouraged to try to correct the interference by one or more of the following measures:

1. Reorient or relocate the receiving antenna.
2. Increase the separation between the equipment and receiver.
3. Connect the equipment into an outlet on a circuit different from that to which the receiver is connected.
4. Consult the dealer or an experience radio/TV technician for help.

WEEE Warning



To avoid the potential effects on the environment and human health as a result of the presence of hazardous substances in electrical and electronic equipment, end users of electrical and electronic equipment should understand the meaning of the crossed-out wheeled bin symbol. Do not dispose of WEEE as unsorted municipal waste and have to collect such WEEE separately.

GNU GPL Information

Yealink SIP-T48G IP phone firmware contains third-party software under the GNU General Public License (GPL). Yealink uses software under the specific terms of the GPL. Please refer to the GPL for the exact terms and conditions of the license.

The original GPL license, source code of components licensed under GPL and used in Yealink products can be downloaded online:

<http://www.yealink.com/GPLOpenSource.aspx?BaseInfoCatId=293&NewsCatId=293&CatId=293>.

About This Guide

Thank you for choosing the SIP-T48G IP phone, an ultra-elegant Gigabit IP phone which is exquisitely designed to provide business telephony features, such as Call Hold, Call Transfer, Busy Lamp Field, Call Recording, Multicast Paging and Conference over an IP network. It also features an enhanced user experience and newly developed industrial designs, with a large touch screen for easy and efficient use.

This guide provides everything you need to quickly use your new phone. First, verify with your system administrator that the IP network is ready for phone configuration. Also be sure to read the Packaging Contents and Regulatory Notices sections in this guide before you set up and use the SIP-T48G IP phone.

Table of Contents

GNU GPL Information.....	3
About This Guide.....	4
Overview.....	8
Hardware Component Instructions.....	8
Icon Instructions.....	10
LED Instructions.....	11
Getting Started	12
Packaging Contents	12
Phone Installation	13
Phone Initialization.....	16
Phone Status	16
Touch Screen Display	17
Navigating Menus and Fields.....	19
Entering Data and Editing Fields	20
Customizing Your Phone	24
General Settings.....	24
Wallpaper	24
Backlight.....	25
Contrast	26
Language	26
Time & Date.....	27
Audio Settings	29
Ring Tones	30
Contact Management	32
Directory	32
Local Directory	32
Blacklist.....	45
Call History Management.....	46
System Customizations	51

Headset Use	51
Hotline	52
Basic Call Features	53
Placing Calls.....	53
Answering Calls	55
Ending Calls.....	56
Redialing Numbers	57
Auto Answer	57
Auto Redial	58
Call Mute	60
Call Hold/Resume	61
Do Not Disturb (DND)	62
Call Forward	63
Call Transfer.....	66
Call Waiting.....	68
Conference	68
Local Conference.....	69
Call Park.....	70
Call Pickup.....	70
Anonymous Call.....	71
Anonymous Call Rejection	72
Advanced Phone Features	74
Voice Mail.....	74
Message Waiting Indicator (MWI).....	76
Troubleshooting.....	77
General Issues.....	77
Display Issues.....	77
Call Issues	78
Headset & Handset Issues	78
Audio Issues	78
Regulatory Notices	79
Service Agreements	79

Limitations of Liability.....	79
Safety Instructions	79
Appendix A - Time Zones	82

Overview

This chapter provides the overview of the SIP-T48G IP phone. Topics include:



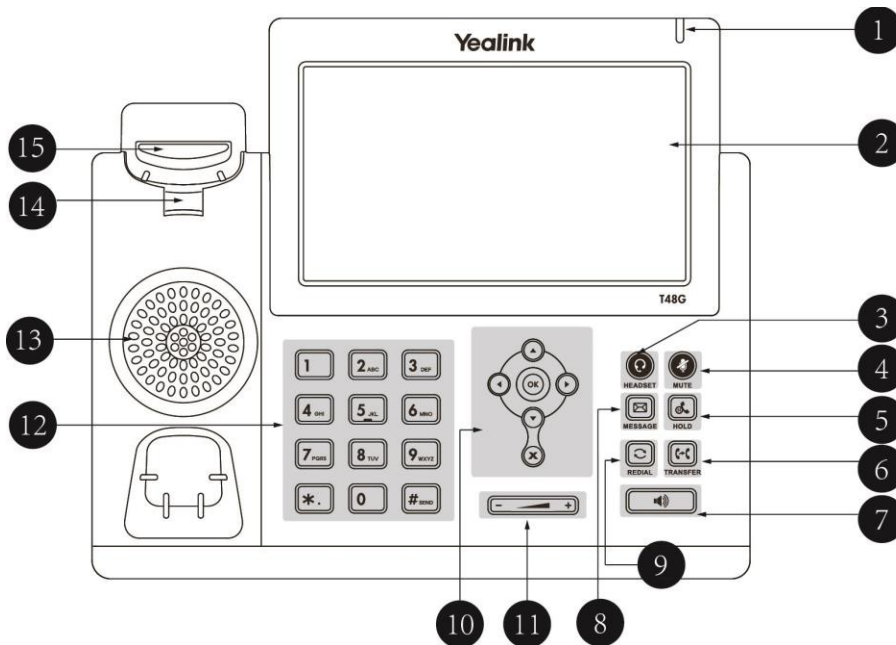

Hardware Component Instructions

The main hardware components of the SIP-T48G IP phone are the touch screen and the keypad.





















Hardware component instructions of the SIP-T48G IP phone are:









Item	Description
1	Power Indicator LED Indicates phone power and some feature statuses. <ul style="list-style-type: none">• Receives an incoming call—Fast flashing• Receives a voice mail or text message—Slow flashing

2	Touch Screen	<p>The screen is touch-sensitive. Tap to select and highlight screen items. Shows information about calls, messages, soft keys, time, date and other relevant data:</p> <ul style="list-style-type: none"> • Call information—caller ID, call duration • Icons (for example, ) • Missed call text or second incoming caller information • Prompt text (for example, "Saving config file!") • Time and date
3	HEADSET Key	Toggles and indicates the headset mode.
4	MUTE Key	Toggles and indicates mute feature.
5	HOLD Key	Places a call on hold or resumes a held call.
6	TRANSFER Key	Transfers a call to another party.
7	Speakerphone Key	Toggles and indicates the hands-free speakerphone mode.
8	MESSAGE Key	Accesses voice messages.
9	REDIAL Key	Redials a previously dialed number.
10		Position the cursor within text you're updating. Enable or disable fields.
		Turn pages or scroll through values for a field. Scroll through items. Access to History and Directory respectively.
		Confirms actions or answers incoming calls.
		Cancel actions or rejects incoming calls.
11	Volume Key	Adjusts the volume of the handset, headset, Speaker phone and ringer.
12	Keypad	Provides the digits, letters and special characters in context-sensitive applications.
13	Speaker	Provides hands-free (speakerphone) audio output.
14	Hookswitch Tab	Secures the handset in the handset cradle when the IP phone is mounted vertically.
15	Hookswitch	Picking up the handset from the handset cradle, the hookswitch bounces and the phone connects to the line, laying the handset down on the handset cradle, the phone disconnects from the line.

Icon Instructions

Icons appearing on the touch screen are described in the following table:

Icons	Description
	Network is unavailable
	The private line registers successfully
	Register failed
(Flashing) 	Registering
	The shared/bridged line registers successfully
	Hands-free speakerphone mode
	Handset mode
	Headset mode
	Voice Mail
	Text Message
	Auto Answer
	Do Not Disturb
	Call Hold
	Call Mute
	Ringer volume is 0
	Phone Lock
	Received Calls
	Placed Calls

	Missed Calls
	Call Forward
	Forwarded Calls
	Recording box is full
	Bluetooth mode is on
	Bluetooth headset is both paired and connected
	Wi-Fi connection is successful
	Wi-Fi connection failed
	The default caller photo and contact icon

LED Instructions

Power Indicator LED

LED Status	Description
Solid red	The phone is initializing.
Fast flashing red	The phone is ringing.
Slow flashing red	The phone receives a voice mail or text message.
Off	The phone is powered off. The phone is idle. The phone is busy. The call is placed on hold or is held. The call is muted.

Getting Started

This chapter provides the following basic installation instructions and information for obtaining the best performance with the SIP-T48G IP phone.

Packaging Contents

The following components are included in your SIP-T48G IP phone package:

- **SIP-T48G IP Phone**

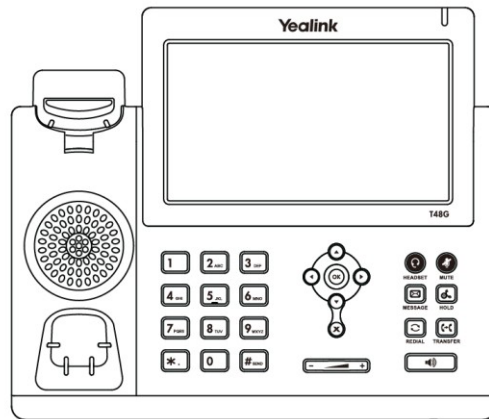

- **Phone Stand**

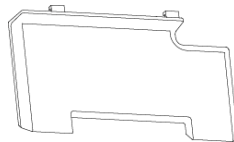

- **Handset & Handset Cord**

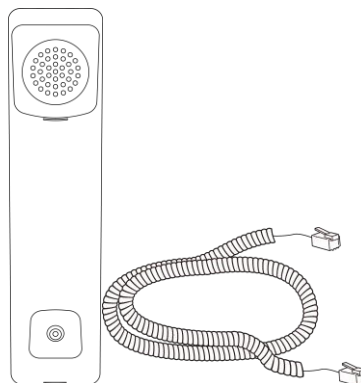

- **Power Adapter**

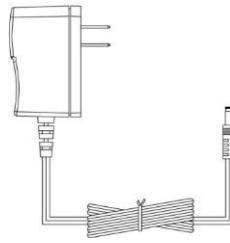

- **Ethernet Cable**

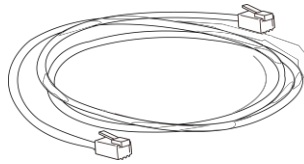

- **Quick Start Guide**

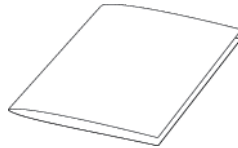

Check the list before installation. If you find anything missing, contact your system administrator.

Phone Installation

This section introduces how to install the phone:

1. Attach the stand
2. Connect the handset and optional headset
3. Connect the network and power

1) Attach the stand

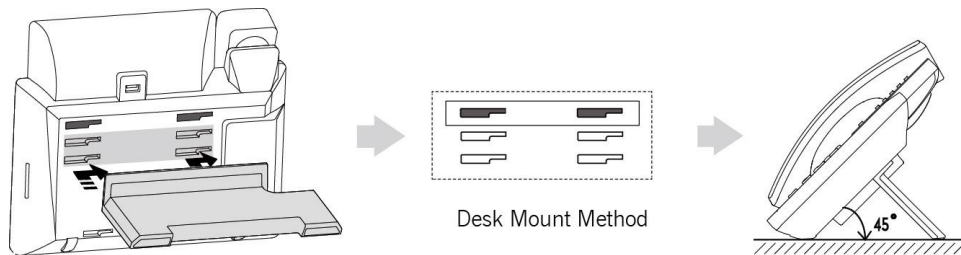

Desk Mount Method

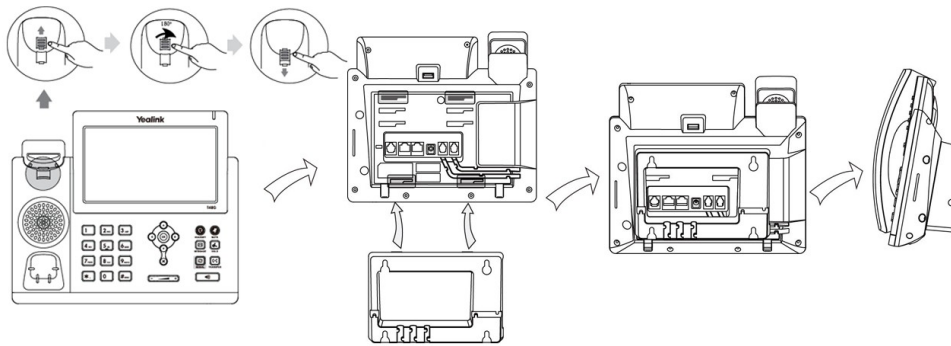

Wall Mount Method (Optional)

2) Connect the handset and optional headset

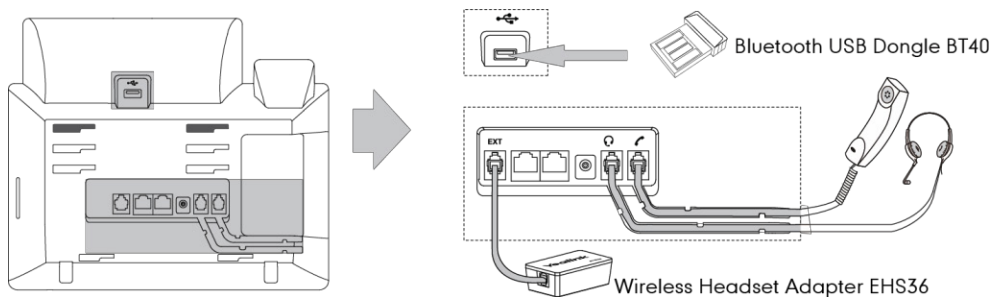

Note

The EXT port can also be used to connect an expansion module EXP40. The USB port can also be used to connect Wi-Fi USB Dongle WF40.

For more information on how to use EHS36, EXP40, Bluetooth USB Dongle BT40 or Wi-Fi USB Dongle WF40, refer to [Yealink EHS36 User Guide](#), [Yealink EXP40 User Guide](#), [Yealink Bluetooth USB Dongle BT40 User Guide](#) or [Yealink Wi-Fi USB Dongle WF40 User Guide](#).

3) Connect the network and power

You have two options for power and network connections. Your system administrator will advise you which one to use.

- AC power (Optional)
- Power over Ethernet (PoE)

Note

The IP phone should be used with Yealink original power adapter (5V/2A) only. The use of the third-party power adapter may cause the damage to the phone.

To connect the AC power:

1. Connect the DC plug on the power adapter to the DC5V port on the phone and connect the other end of the power adapter into an electrical power outlet.
2. Connect the included or a standard Ethernet cable between the Internet port on the phone and the one on the wall or switch/hub device port.

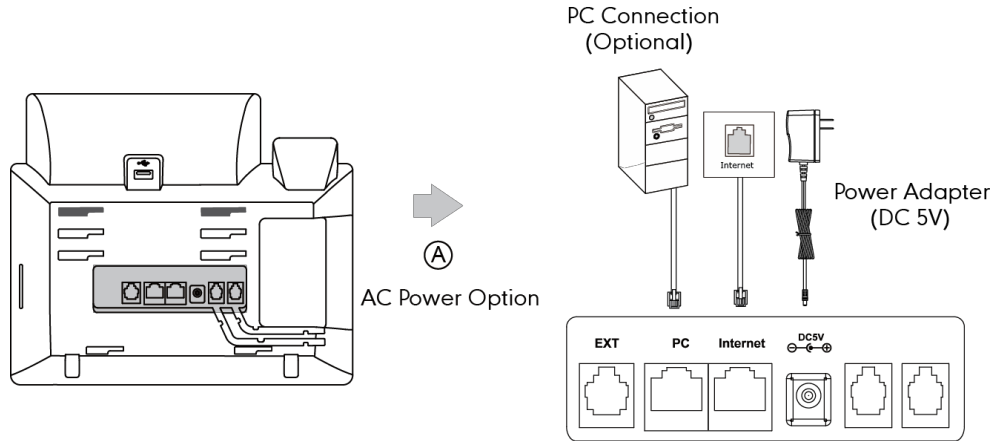

Power over Ethernet

With the included or a regular Ethernet cable, the SIP-T48G IP phone can be powered from a PoE-compliant switch or hub.

To connect the PoE:

Connect the Ethernet cable between the Internet port on the phone and an available port on the in-line power switch/hub.

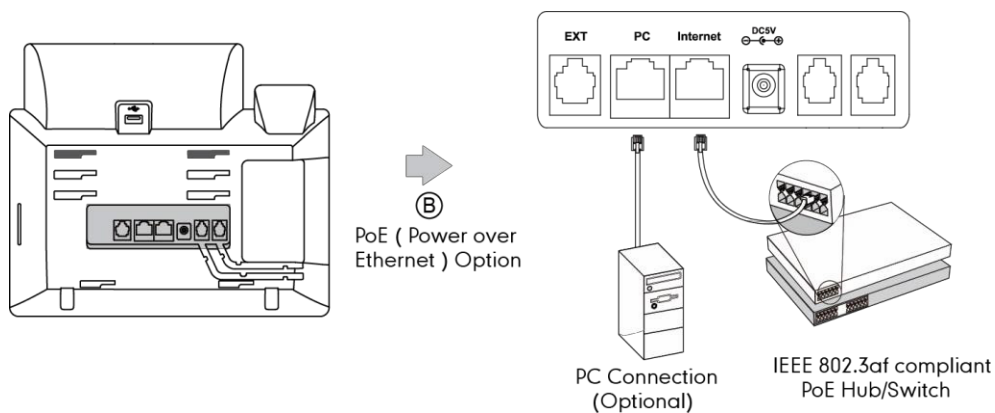

Note

If in-line power is provided, you don't need to connect the phone to the power adapter. Make sure the switch/hub is PoE-compliant.

The phone can also share the network with another network device such as a PC (personal computer). This is an optional connection.

Important! Do not remove power to the phone while it is updating firmware and configurations.

Phone Initialization

After your phone is powered on, the system boots up and performs the following steps:

Automatic Phone Initialization

The phone finishes the initialization by loading the saved configuration. The touch screen displays "Welcome Initializing...Please wait" during the initialization.

DHCP (Dynamic Host Configuration Protocol)

The phone attempts to contact a DHCP server in your network to obtain valid IPv4 network settings (e.g., IP address, subnet mask, default gateway address and DNS address) by default.

Phone Status



You can view phone status via phone user interface or web user interface. Available information of phone status includes:

- General information (IPv4 address, MAC address and firmware version)
- Network status (e.g., IPv4 status, IP mode and MAC address)
- Phone status (e.g., device model, hardware version, product ID, MAC address and device certificate status)
- Account status (e.g., register status of SIP accounts)

Note

You can view the device certificate status via phone user interface only.

To view the phone status via phone user interface:

1. Press , or tap  -> **Status**.







2. Tap the desired item to view the specific information.

Touch Screen Display

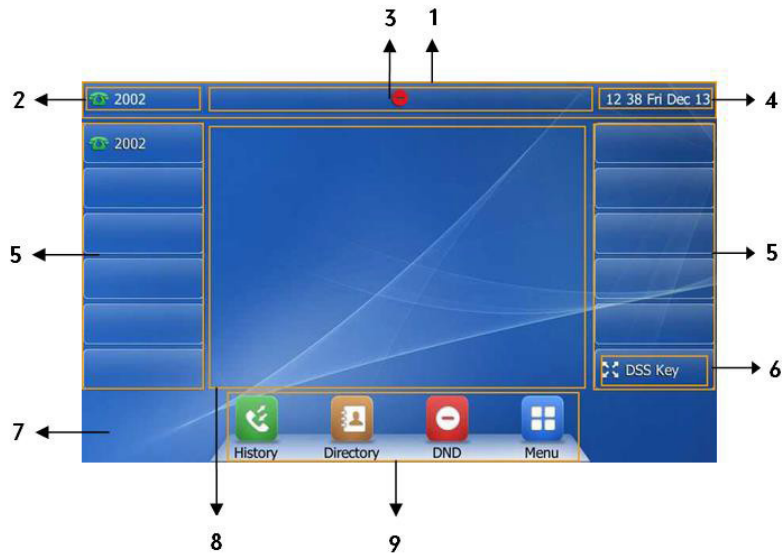
Idle Screen Display

If the phone has successfully started up, the idle screen will be displayed. The following figure is an example of what is displayed on the touch screen.



No.	Name	Description
1	Status Bar	Displays the phone's default account, icons and the time and date.
2	Default Account	The label of the default account is displayed in the left of the status bar. If multiple accounts are already registered, tap and select the desired default account.
3	Icons	Icons are displayed in the middle of the status bar.
4	Time and Date	The phone's time and date are displayed in the right of the status bar.
5	Line Keys (1-11)	The idle screen displays line keys 1-11. The line keys 1-6 on the left and the line keys 7-11 on the right can be used to activate up to 11 lines. Various features can be assigned to line keys. Each line key can display the label and indicate the status of the assigned feature.
6	DSS Key	Provides a quick access to the line key screen. Then, you can tap the desired line key to configure it.
7	Wallpaper	Shows the specified wallpaper, which can be customized.
8	Call Window	Displays call information.
9	Shortcut Keys	 : tap this shortcut key to enter the History screen and view call history.  : tap this shortcut key to enter the Directory screen and view contacts.  : tap this shortcut key to toggle the DND mode or enter the custom DND configuration screen.  : tap this shortcut key to enter the main menu.

Configuration Screen Display



No.	Name	Description
1	Screen Title Area	Displays the title of the current menu screen.
2	Operation Option Area	Displays various operation options for different menu screens.
3	Menu Tree Area	Displays menu items. Tap the desired menu item to enter the corresponding feature configuration screen.
4	Configuration Area	Displays configuration items of the highlighted menu item in the menu tree area. You can configure feature settings in this area.
5	Soft Keys	Label automatically to identify their context-sensitive features.

Navigating Menus and Fields















To navigate menus and fields, you can:

- Tap soft keys on the touch screen.
- Tap menu items, fields, and arrows on the touch screen.
- Press keys on the phone keypad.

Note

The menu system will automatically exit to the idle screen after 60 seconds of inactivity.

To operate your phone, follow these tips:













If you want to	Action
Enter the main menu.	Tap  .
Return to the idle screen.	Tap  .
Go back to the previous menu.	Tap  or press  .
Select an item.	Tap the item. Scroll to the item by pressing  or  .
Scroll through items page by page.	Tap  or  .
Scroll through values for a field.	(If you are in the call history, local directory, language configuration screen or ring tones configuration screen, you can also press  or  .) Tap the field's highlighted gray box. From the pull-down list, tap  or  to scroll through values page by page, or press  or  to scroll values one by one.
Select a value for a field.	From the pull-down list, tap the value or scroll to the value and then press  .

Entering Data and Editing Fields

You can enter data and edit fields using the phone keypad.













Keypad on the phone provides different characters when using the 2aB, abc, Abc, ABC or 123 input mode. You can change the following input modes to enter data and edit fields on your phone. When your phone keypad matches the input mode, you can press the keypad repeatedly to view the character (or numbers) options and stop to select. When the character (or numbers) you want to enter displays in the field, wait one second, and enter the next character (or numbers).

The following table lists the input modes and character (or numbers) options for the keypad:



Input Mode Keypad	2aB	abc	Abc (initials in capitals)	ABC	123
	1				1
	2abcABC	abc2äæå àáâãç	abc2äæå àáâãç	ABC2ÄÆÅ AAAÄÇ	2
	3defDEF	def3éêëè ò	def3éêëè ò	DEF3ÉÊËÈ Ò	3
	4ghiGHI	ghi4íîï	ghi4íîï	GHI4ÍÎÏ	4
	5jklJKL	jkl5€	jkl5€	JKL5€	5
	6mnoMN O	mnoóöøò óôõñ	mnoóöøò óôõñ	MNOóÖØ ÓÓÖÑ	6
	7pqrsPQR S	pqrs7ß	pqrs7ß	PQRS7	7
	8tuvTUV	tuv8ùúû	tuv8ùúû	TUV8ÙÚÛ	8
	9wxyzWX YZ	wxyz9ýþ	wxyz9ýþ	WXYZ9ÝÞ	9
	0	space	space	space	0
	*.?!\-()@/: _;&%=< > \$¥α[]{} ~^i¿§#~	*.?!\-()@/: _;&%=< > \$¥α[]{} ~^i¿§#~	*.?!\-()@/: _;&%=< > \$¥α[]{} ~^i¿§#~	*.?!\-()@/: _;&%=< > \$¥α[]{} ~^i¿§#~	*.:/@[]
	#	#	#	#	#

To enter or edit data:

1. Tap the field.
2. Do one of the following:

If you want to	Then you can
Enter only digits (1), uppercase (A) characters, lowercase (a) characters, or alphanumeric (2aB) characters.	<p>Press a keypad key one or more times (depending what input mode you're in) to enter the characters that is displayed on the keypad key.</p> <p> You can tap  or abc one or more times to switch among uppercase (ABC), numeric (123), alphanumeric (2aB), uppercase and lowercase (Abc) and lowercase (abc) input modes.</p> <p>For example, if the input mode is ABC:</p> <ul style="list-style-type: none">• To enter "A", press  once.• To enter "B", press  twice quickly.• To enter "C", press  three times quickly.• To enter "2ÄËÄÄÄÄÄÇ", press  more than three times quickly. <p>Note: When you are in the uppercase (ABC), uppercase and lowercase (Abc) or lowercase (abc) input mode,  is not available.</p>
Enter special characters.	<p>Press the keypad key  or  , or press .</p> <p>For  Key:</p> <p>If it is in the uppercase (ABC soft key), uppercase and lowercase (Abc soft key) or lowercase (abc soft key) input mode, it will provide the space character.</p> <p>If it is in the numeric (123 soft key) or alphanumeric (2aB soft key) input mode, it will only provide the digit 0.</p> <p>For  key:</p> <p>It only provides the pound character #.</p> <p>For  key:</p> <p>If it is in the uppercase (ABC), lowercase (abc), uppercase and lowercase (Abc) or alphanumeric (2aB) input mode, it will provide the following special characters: *.,?!\~()@/:_+&%=<> \$¥¤[]{}~^_`¡¢£\$%&'".</p> <p>If it is in the numeric (123) input mode, it will provide the following special characters: .*/@[].</p>

Delete text you entered.

Press  or  to position the cursor to the right of the text you want to delete, and then tap **Delete**  to delete one character at a time.

Delete an entire field of data.

Swipe your finger to the left or right to select the entire field of data, so that the data highlighted, and then tap the **Delete** or .

3. Press .

Customizing Your Phone

You can customize your SIP-T48G IP phone by personally configuring certain settings, for example, wallpaper, time & date and ring tones. You can add contacts to the phone's local directory manually or from call history. You can also personalize different ring tones for different callers.

General Settings

Wallpaper

You can customize the wallpaper of the SIP-T48G IP phone, and can change the wallpaper image via phone user interface.

To change the wallpaper via phone user interface:

1. Tap  -> **Basic**->**Display**->**Wallpaper**.
2. Tap  or , or press  or  to select the desired wallpaper image.



3. Tap the **Save** soft key to accept the change or  to cancel.

The web user interface prompts "Upload success!". The custom picture appears in **Screensaver** list. The first picture in the list is System.jpg. You can only delete the custom picture by clicking Del in the **Screensaver** field.

Note

You can only upload one custom image at a time via web user interface.

Backlight

Backlight has three options:

Backlight Active Level: The intensity of the touch screen when the phone is active. You can change the intensity of the touch screen. Digits (1-10) represent different intensities. 10 is the highest intensity.

Backlight Inactive Level: The intensity of the touch screen when the phone is inactive. You can select a low intensity or turn off the backlight.

Backlight Time: The delay time to change the intensity of the touch screen when the phone is inactive. You can select a desired time to change the intensity or turn on the backlight permanently.

- **Always On:** Backlight is on permanently.
- **15s, 30s, 60s, 120s, 300s, 600s or 1800s:** Backlight is changed when the phone is inactive after the designated time (in seconds).

You can also change the intensity of the LCD screen of EXP40 connected to the SIP-T48G IP phone.

To configure the backlight via phone user interface:

1. Tap  -> **Basic->Display->Backlight.**
2. Tap the gray box of the **Backlight Active Level** field, and then select the desired level from the pull-down list.
3. Tap the gray box of the **Backlight Inactive Level** field, and then select the desired value from the pull-down list.
4. Tap the gray box of the **Backlight Time** field, and then select the desired time from the pull-down list.

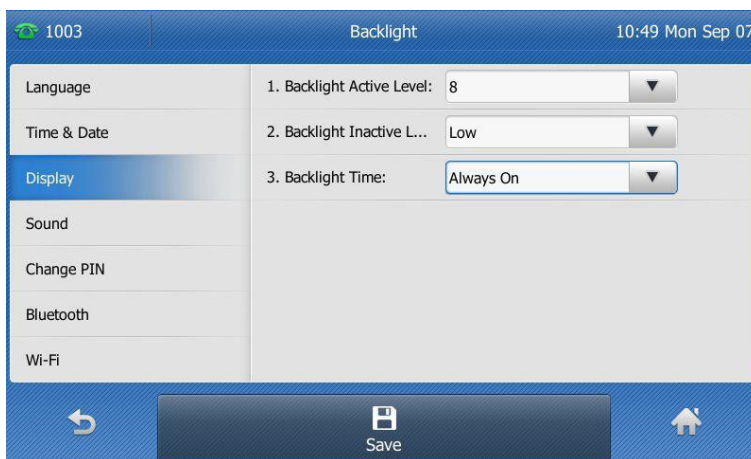

5. Tap the Save soft key to accept the change or  to cancel.

Backlight is configurable via web user interface at the path **Settings->Preference.**

Contrast

You can only configure the contrast of the expansion module EXP40 connected to the SIP-T48G IP phone to a comfortable level on the phone. Ensure that the expansion module has been connected to the phone before configuration. The intensity of contrast ranges from 1 to 10 and the highest intensity is 10.

To configure the contrast via phone user interface:

1. Tap  -> **Basic->Display->Contrast Setting**.
If EXP40 is not connected to the phone, the Contrast Setting screen displays “No EXP”.
2. Tap the gray box of the Contrast Setting field, and then select the desired value from the pull-down list. The default contrast level is “6”.

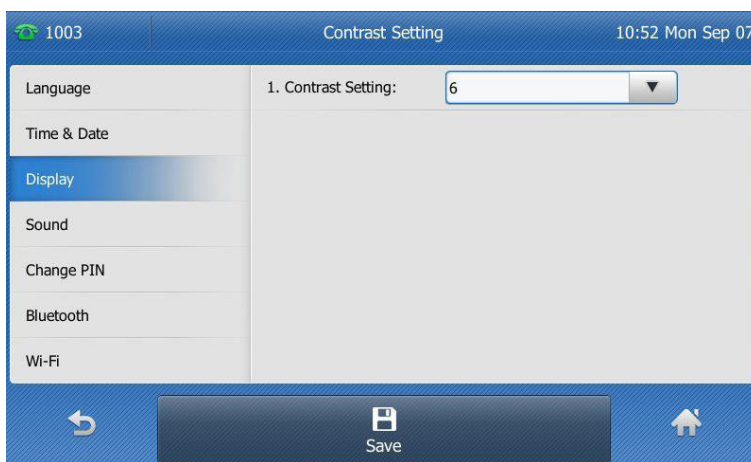

3. Tap the Save soft key to accept the change or  to cancel.

Language

The default language of the phone user interface is English. If the language of your web browser is not supported by the phone, the web user interface will use English by default. You can change the language for the phone user interface and the web user interface respectively.

To change the language for the phone user interface:

1. Tap  -> **Basic->Language**.
2. Tap ▲ or ▼ to scroll through the list of available languages.
3. Tap the desired language.



4. Tap the Save soft key to accept the change.
Text displayed on the phone user interface will change to the selected language.

Time & Date

The time and date are displayed on the right of the status bar. You can configure the phone to obtain the time and date from the SNTP server automatically, or configure the time and date manually. If the phone cannot obtain the time and date from the Simple Network Time Protocol (SNTP) server, contact your system administrator for more information.

To configure the time and date manually via phone user interface:

1. Tap  -> **Basic**->**Time & Date**->**General**.
2. Tap the gray box of the **Type** field, and then select **Manual Settings** from the pull-down list.
3. Enter the specific date and time in the corresponding fields.



4. Tap the **Save** soft key to accept the change.
The time and date displayed on the touch screen will change accordingly.

There are 7 available date formats. For example, for the date format “WWW DD MMM”, “WWW” represents the abbreviation of the weekday, “DD” represents the two-digit day, and “MMM” represents the first three letters of the month.

The date formats available:

Date Format	Example (2015-05-18)
WWW MMM DD	Mon May 18
DD-MMM-YY	18-May-15
YYYY-MM-DD	2015-05-18
DD/MM/YYYY	18/05/2015
MM/DD/YY	05/18/15
DD MMM YYYY	18 May 2015
WWW DD MMM	Mon 18 May

To configure the date and time format via phone user interface:

1. Tap  -> **Basic**->**Time & Date**->**Time & Date Format**.
2. Tap the gray box of the **Date Format** field, and then select the desired date format from the pull-down list.
3. Tap the gray box of the **Time Format** field, and then select the desired time format (**12 Hour** or **24 Hour**) from the pull-down list.

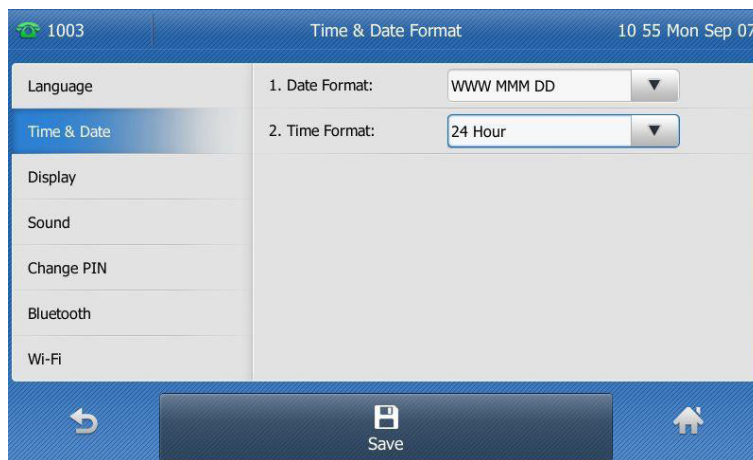

4. Tap the **Save** soft key to accept the change or  to cancel.

Time and date are configurable via web user interface at the path **Settings->Time & Date**.

Audio Settings

Volume

You can press the Volume key to adjust the ringer volume when the phone is idle or ringing. You can also press the Volume key to adjust the receiver volume of currently engaged audio devices (handset, speakerphone or headset) when the phone is in use.

To adjust the ringer volume:

When the phone is idle:

1. Press  to adjust the ringer volume.



When the phone is ringing:

1. Press  to adjust the ringer volume.

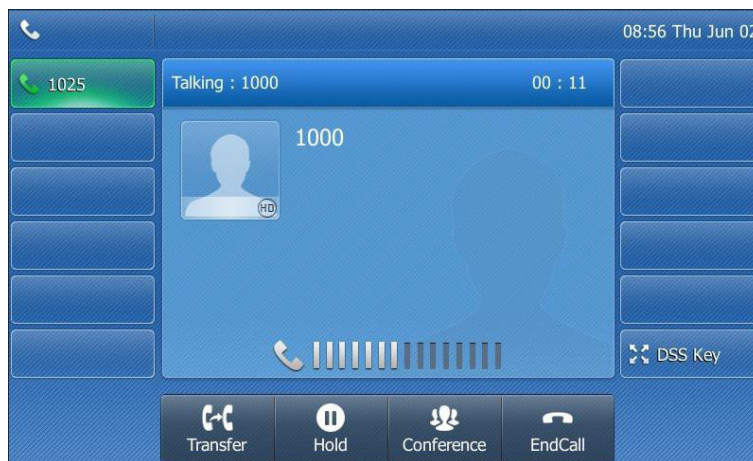

You can also press  to adjust the ringer volume when selecting a ring tone.

Note

If the ringer volume is adjusted to minimum, the  icon will appear on the touch screen.

To adjust the volume when the phone is during a call:

1. Press  to adjust the volume of currently engaged audio device (handset, speakerphone or headset).





Ring Tones

Ring tones are used to indicate incoming calls. You can select different ring tones to distinguish different accounts registered on your phone, or to distinguish your phone from your neighbor's.

To select a ring tone for the phone via phone user interface:

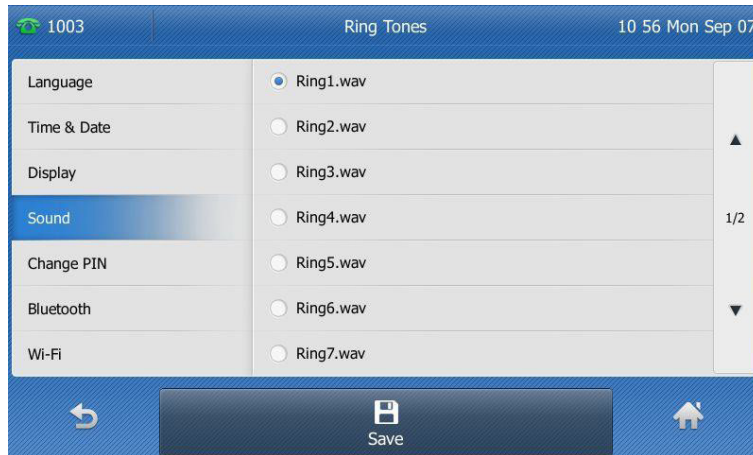
1. Tap  -> **Basic**->**Sound**->**Ring Tones**->**Common**.
2. Tap the desired ring tone.





3. (Optional.) Press  to adjust the ringer volume.
4. Tap the **Save** soft key to accept the change or  to cancel.

A ring tone for the phone is configurable via web user interface at the path **Settings->Preference->Ring Type**.

To select a ring tone for the account via phone user interface:

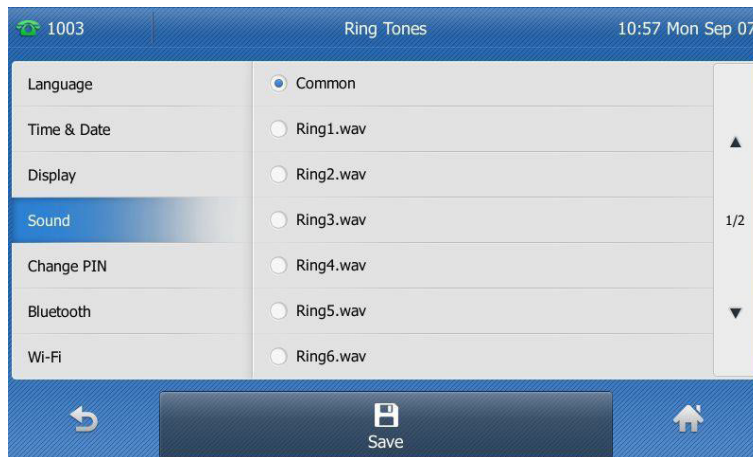
1. Tap ->**Basic->Sound->Ring Tones**.
2. Tap the desired account.
3. Tap the desired ring tone.
If **Common** is selected, this account will use the ring tone selected for the phone.



4. (Optional.) Press  to adjust the ringer volume.
5. Tap the **Save** soft key to accept the change or  to cancel.

A ring tone for the account is configurable via web user interface at the path **Account->Basic->Ring Type**.



Contact Management

This section provides the operating instructions for managing contacts.

Directory

Directory provides easy access to frequently used lists. The lists may contain Local Directory, History or Remote Phone Book.

To view the directory via phone user interface:

1.  when the phone is idle.
 - If only one list is enabled for the directory, tap  to view the list directly.

If more than one list is enabled for the directory, tap the desired list you want to view, and then tap **OK**.



Local Directory

The built-in phone directory can store the names and phone numbers of your contacts. You can store up to 1000 contacts and 48 groups in your phone's local directory. You can add new groups and contacts, edit, delete or search for a contact, or simply dial a contact number from the local directory.

Adding Groups

To add a group to the local directory:

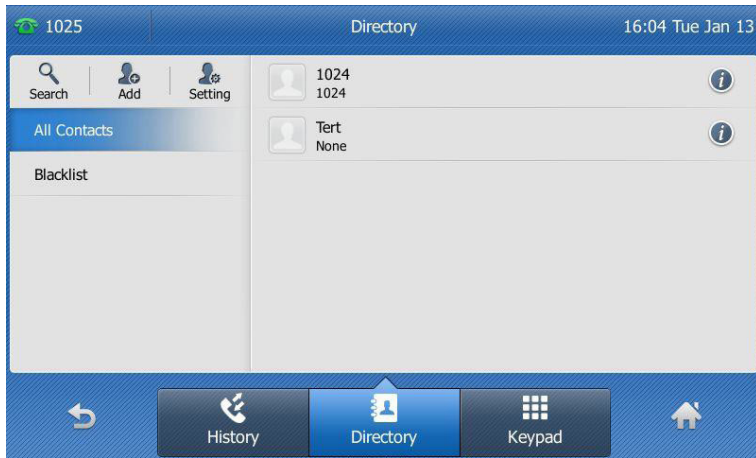

1. Tap  .
The IP phone enters the local directory directly as there is only Local Directory enabled in the directory by default.

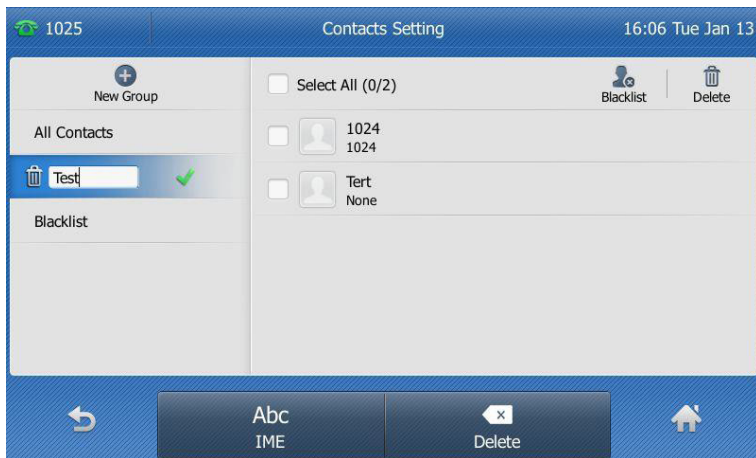

If Local Directory is removed from the directory, tap  -> **Directory**-> **All Contacts** to enter the local directory.

2. Tap **Setting**.
3. Tap **New Group**.
4. Enter the desired group name in the highlighted field.



5. Tap  to accept the change.
6. Tap  to specify a ring tone for the group.
7. Tap the desired ring tone.



If **Auto** is selected, this group will use the ring tone according to the priority: Contact ring tone >Account ring tone >Phone ring tone. If a specific ring tone is selected, this group will use the ring tone according to the priority: Contact ring tone > Group ring tone.

8. Tap **OK** to accept the change.

You can also edit or delete any newly added contact groups.

Editing Groups

To edit a group in the local directory:

1. Tap  .
The IP phone enters the local directory directly as there is only Local Directory enabled in the directory by default.



If Local Directory is removed from the directory, tap  ->**Directory->All Contacts** to enter the local directory.

2. Tap **Setting**.
3. Tap the desired group.
4. Tap  after the group name.

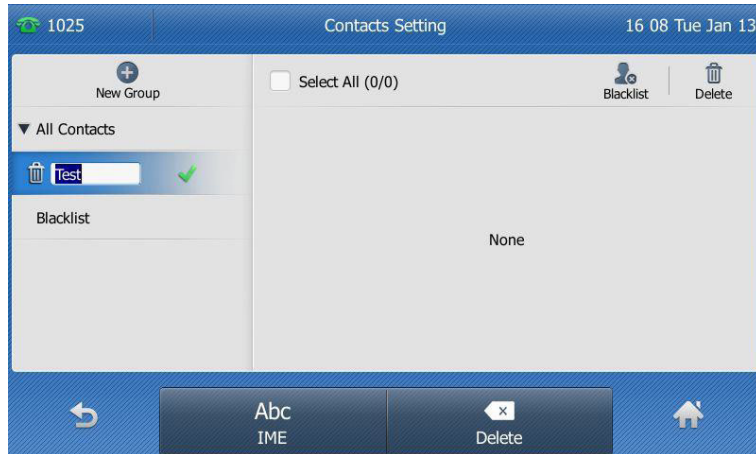

5. Edit the group name in the highlighted field.
6. Tap  to accept the change.

Deleting Groups

To delete a group from the local directory:

1. Tap  .
The IP phone enters the local directory directly as there is only Local Directory enabled in the directory by default.

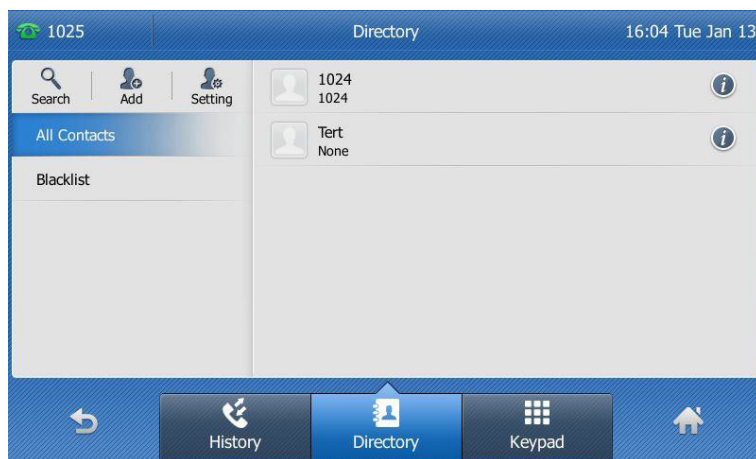

If Local Directory is removed from the directory, tap  -> **Directory**-> **All Contacts** to enter the local directory.

2. Tap **Setting**.
3. Tap the desired group.
4. Tap  before the group name.
The touch screen prompts the following warning:

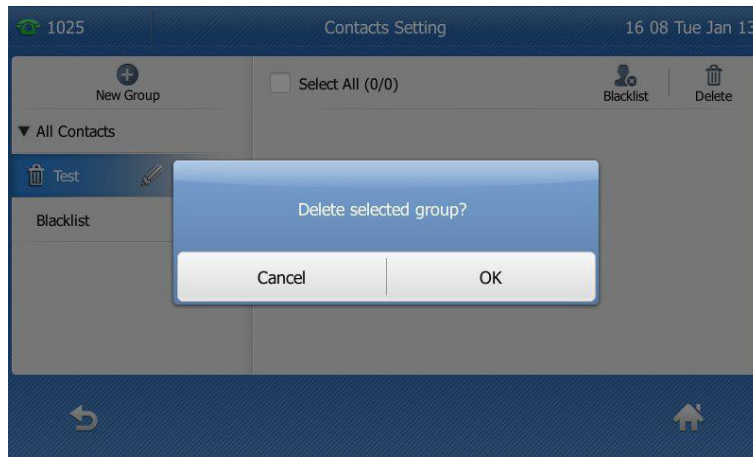

5. Tap **OK** to confirm the deletion or **Cancel** to cancel.

Adding Contacts

You can add contacts to the local directory in one of the following ways:

- Manually
- From call history
- From a remote phone book

Adding Contacts Manually

To add a contact to the local directory manually:

1. Tap .
The IP phone enters the local directory directly as there is only Local Directory enabled in the directory by default.

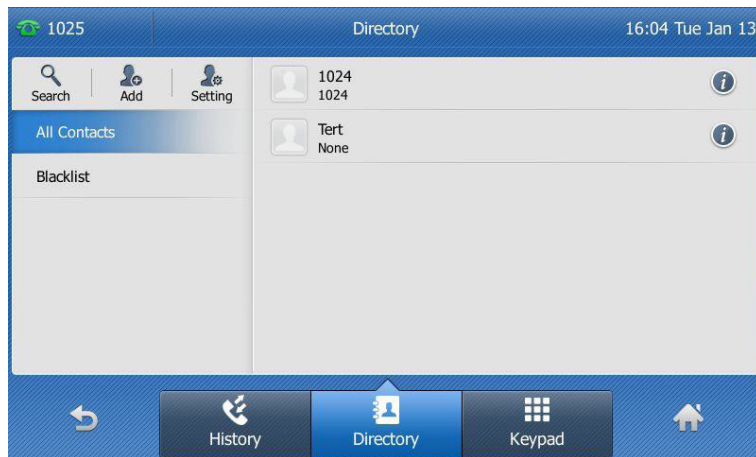

If Local Directory is removed from the directory, tap  -> **Directory**->**All Contacts** to enter the local directory.

2. Tap **Add**.
If you want add a contact to the specified contact group, you can tap the contact group first, and then tap **Add**.
3. Enter the name and the office, mobile or other numbers in the corresponding fields.

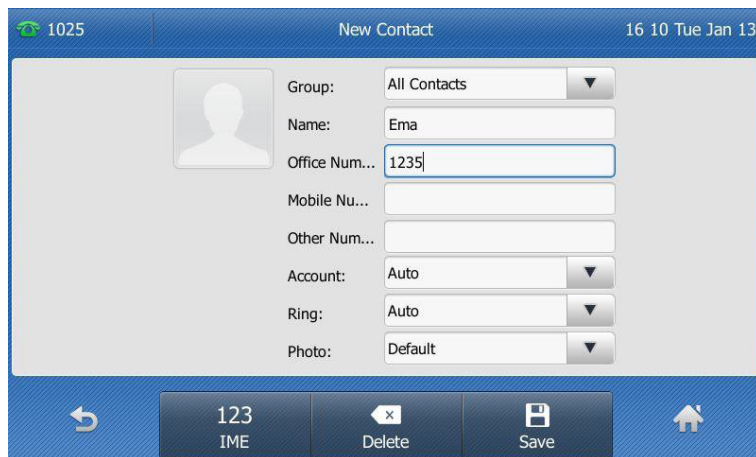



4. Tap the gray box of the **Account** field, and then select the desired account from the pull-down list. If **Auto** is selected, the phone will use the default account when placing calls to the contact from the local directory.
5. Tap the gray box of the **Ring** field, and then select the desired ring tone from the pull-down list. If **Auto** is selected, this contact will use the ring tone according to the priority: Group ring tone >Account ring tone >Phone ring tone.
6. Tap the gray box of the **Photo** field, and then select the desired photo from the pull-down list.
7. Tap the **Save** soft key to accept the change or  to cancel.

Note

If the contact already exists in the directory, the touch screen will prompt "Contact name existed!".

Adding Contacts from Call History

To add a contact to the local directory from call history:

1. Tap .
2. Tap ▲ or ▼ to turn pages.
You can also press ⬆ or ⬇ to switch pages.
3. Tap  after the desired entry.

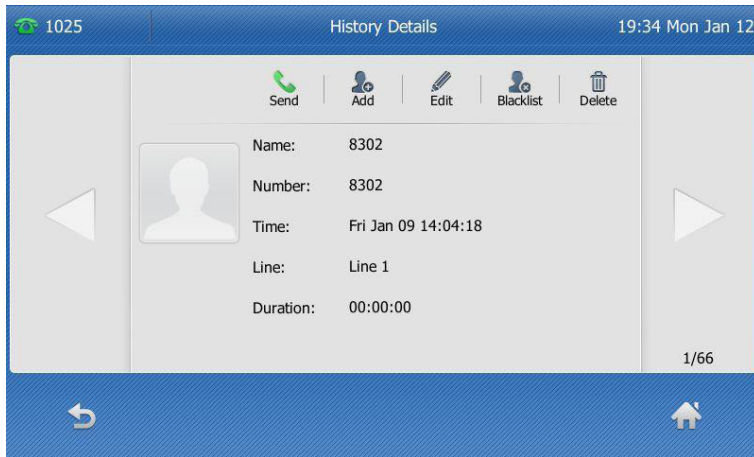

4. Tap **Add**.
5. Edit the corresponding fields.

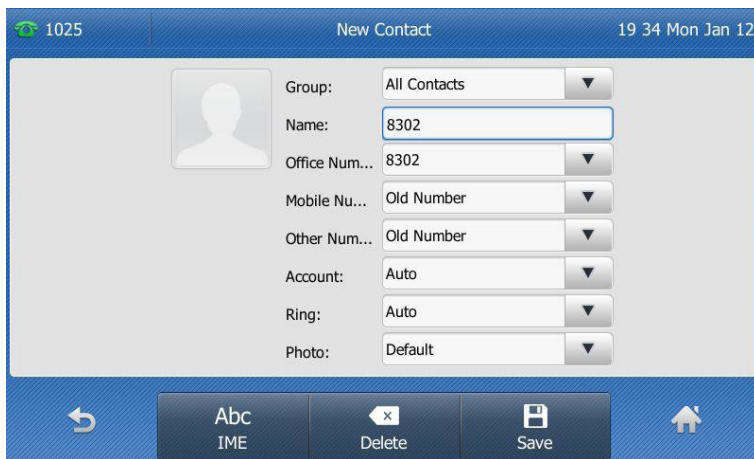



6. Tap the **Save** soft key to accept the change.
The entry is successfully saved to the local directory.

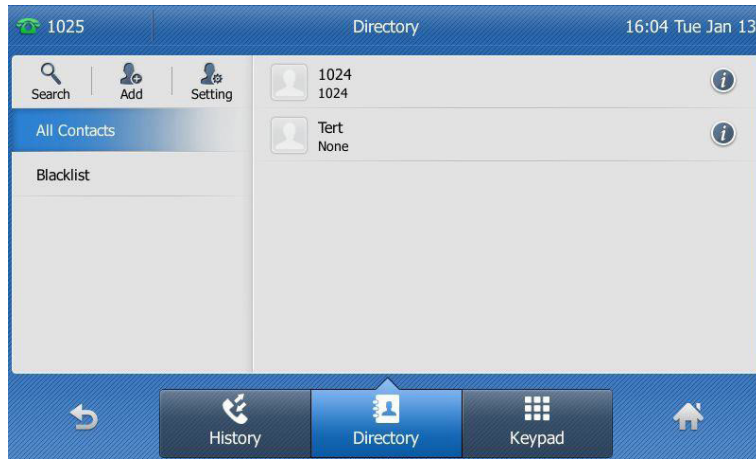

Editing Contacts

To edit a contact in the local directory:



1. Tap  .
The IP phone enters the local directory directly as there is only Local Directory enabled in the directory by default.

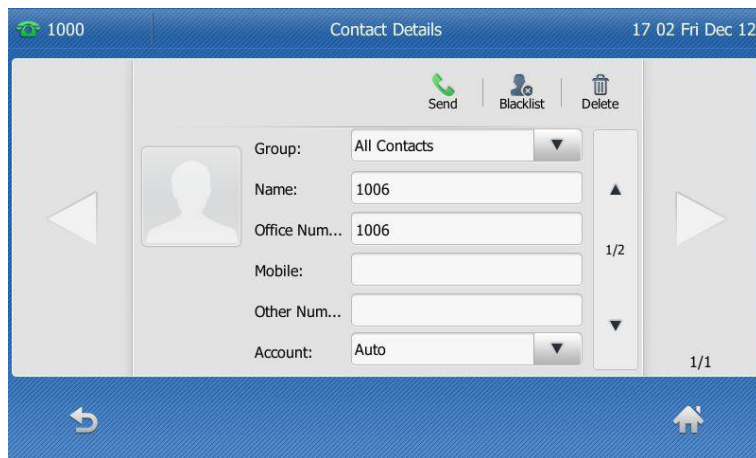

If Local Directory is removed from the directory, tap  -> **Directory->All Contacts** to enter the local directory.

2. Tap  after the desired contact.
If the contact was added to a specified contact group, you can tap the contact group first, and then tap  after the desired contact.
3. Tap the desired field to edit the contact information.



You can tap  or  to switch the contact you want to edit.

4. Tap the **Save** soft key to accept the change or  to cancel.

Deleting Contacts

To delete a contact from the local directory:

1. Tap  .
The IP phone enters the local directory directly as there is only Local Directory enabled in the directory by default.

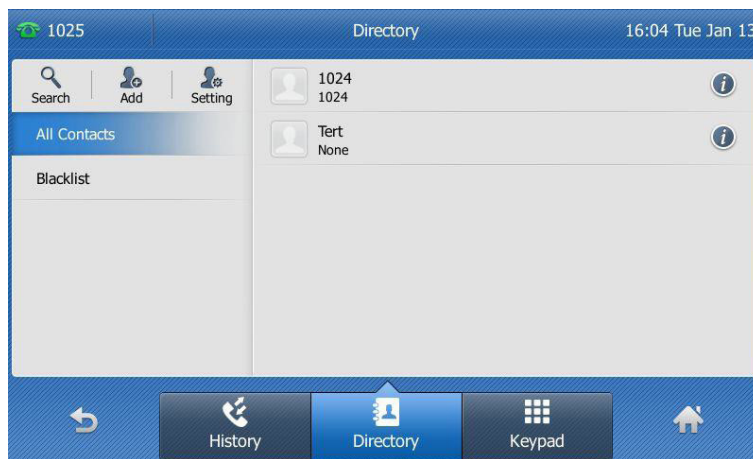

If Local Directory is removed from the directory, tap  -> **Directory**-> **All Contacts** to enter the local directory.

2. Tap  after the desired contact.

If the contact was added to a specified contact group, you can tap the contact group first, and then tap  after the desired contact.

3. Tap **Delete**.

The touch screen prompts the following warning:

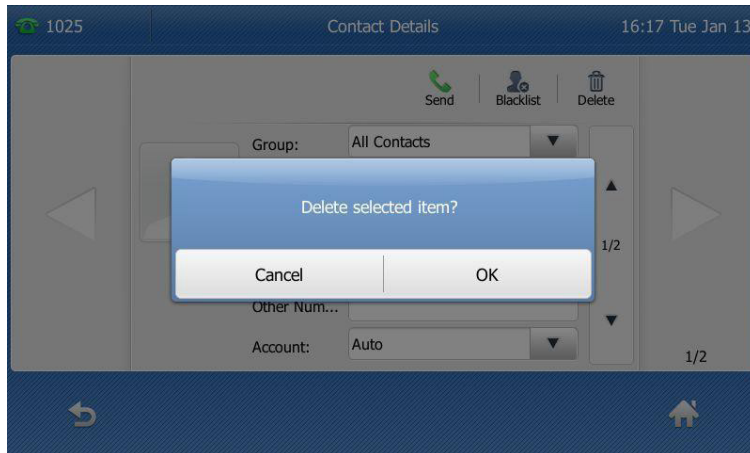

4. Tap **OK** to confirm the deletion or **Cancel** to cancel.

To delete all contacts:

1. Tap . The IP phone enters the local directory directly as there is only Local Directory enabled in the directory by default.



If Local Directory is removed from the directory (refer to [Directory](#) on page 51), tap  ->**Directory**->**All Contacts** to enter the local directory.

2. Tap **Setting**.
3. Tap the checkbox of **Select All**.
4. Tap **Delete**.

The touch screen prompts the following warning:

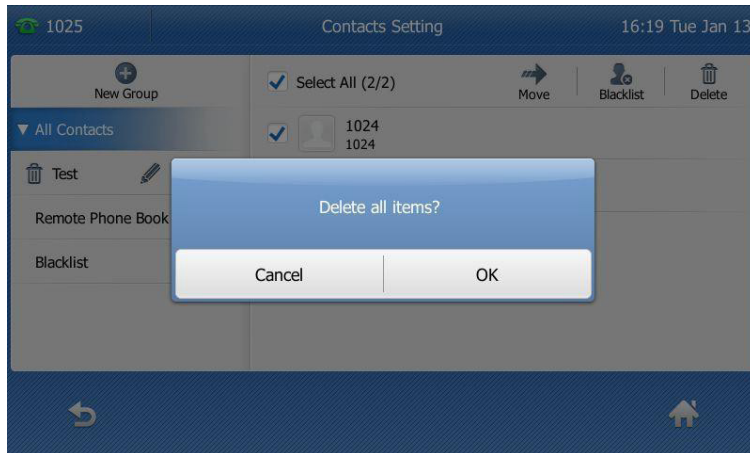

5. Tap **OK** to confirm the deletion or Cancel to cancel.

Placing Calls to Contacts

To place a call to a contact from the local directory:

1. Tap  .
The IP phone enters the local directory directly as there is only Local Directory enabled in the directory by default.



If Local Directory is removed from the directory, tap  -> **Directory**->**All Contacts** to enter the local directory.

2. Tap the desired contact.
If the contact was added to a specified contact group, you can tap the contact group first, and then tap the desired contact.
 - If only one number for the contact is stored in the local directory, the contact number will be dialed out.

- If multiple numbers for the contact are stored in the local directory, the touch screen will prompt:

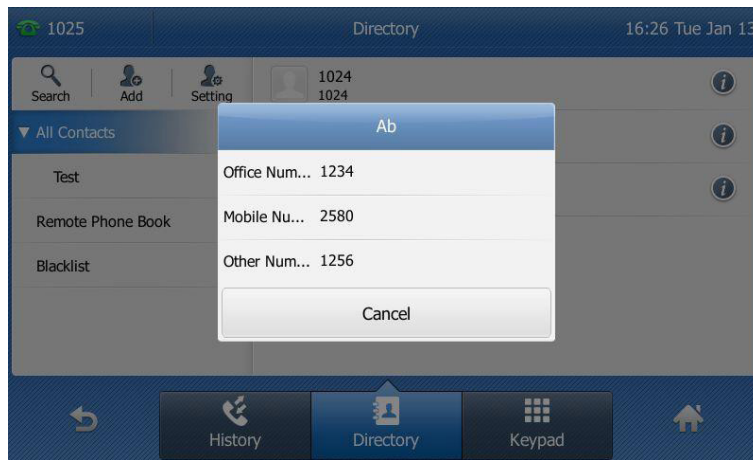

Tap the desired number.

The selected number will be dialed out.

Searching for Contacts

To search for a contact in the local directory:

1. Tap .

The IP phone enters the local directory directly as there is only Local Directory enabled in the directory by default.

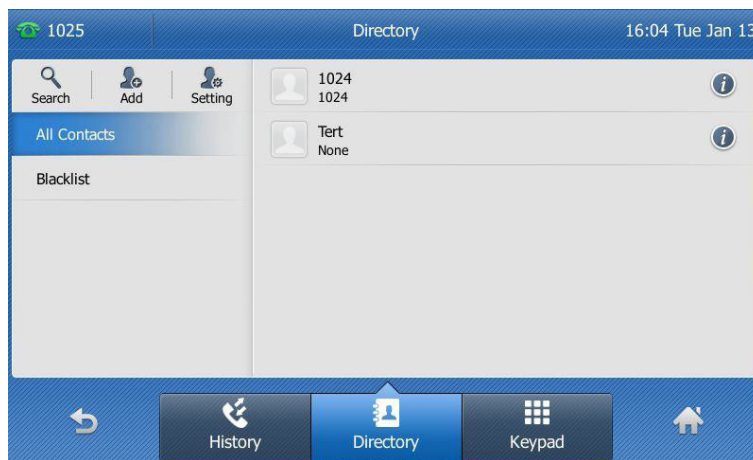

If Local Directory is removed from the directory, tap  -> **Directory**-> **All Contacts** to enter the local directory.

2. Tap **Search**.
3. Enter a few continuous characters of the contact name or continuous numbers of the contact number (office, mobile or other number) using the keypad.



The contacts whose name or phone number matches the characters entered will appear on the touch screen. You can dial from the result list.

Search Source List in Dialing

You can search for a contact from the desired lists when the phone is on the dialing screen. The lists can be Local Directory or History.

To search for an entry in the enabled search source lists:

4. Pick up the handset, press the Speakerphone key or tap the line key.
5. Enter a few continuous characters of the entry's name or continuous numbers of the entry's phone number (office, mobile or other number).

The entries in the enabled search source lists whose name or phone number matches the characters entered will appear on the touch screen.

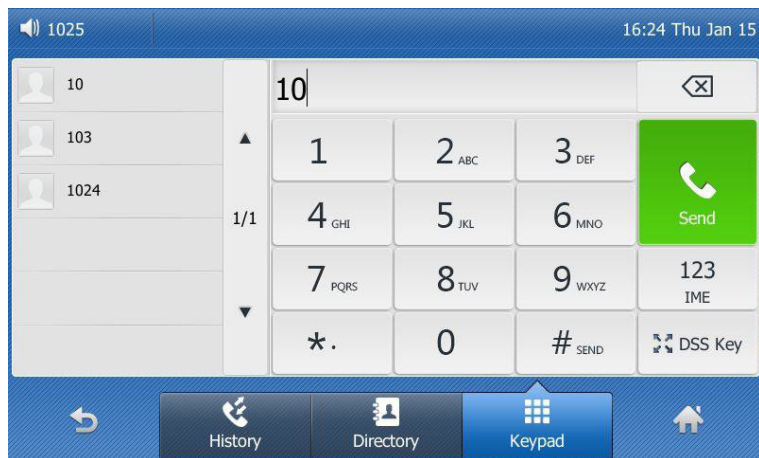

You can tap the desired entry to place a call to the entry.



Blacklist

The built-in phone directory can store names and phone numbers for a blacklist. You can store up to 30 contacts; add, edit, delete or search for a contact in the blacklist directory, and even call a contact from the blacklist directory. Incoming calls from the blacklist directory contacts will be rejected automatically.

To add a contact to the blacklist directory manually:

1. Tap  ->Blacklist or tap  ->**Directory->Blacklist** to enter the blacklist directory.
2. Tap **Add**.
3. Enter the contact's name and the office, mobile or other numbers in the corresponding fields.

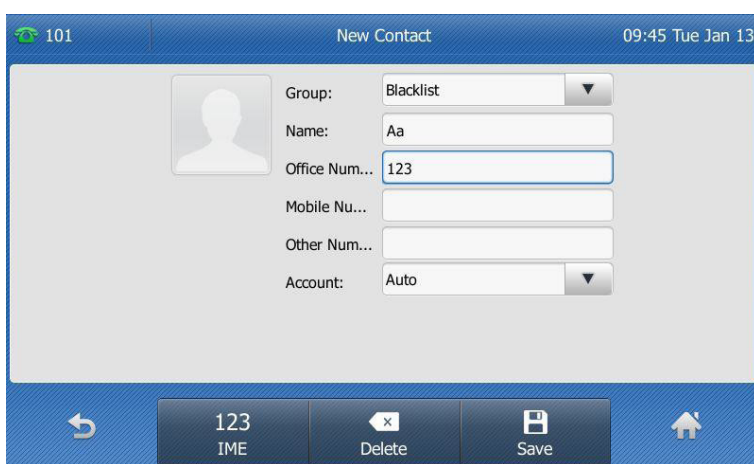

The screenshot shows the 'New Contact' screen with the following fields and values:

- Group: Blacklist
- Name: Aa
- Office Num...: 123
- Mobile Nu...: (empty)
- Other Num...: (empty)
- Account: Auto

At the bottom, there are four soft keys: a back arrow, '123 IME', 'Delete', and 'Save'.



4. Tap the gray box of the Account field, and then select the desired account from the pull-down list. If **Auto** is selected, the phone will use the default account when placing calls to the contact from the blacklist directory.
5. Tap the Save soft key to accept the change or  to cancel.

To add a contact to the blacklist directory from the local directory:

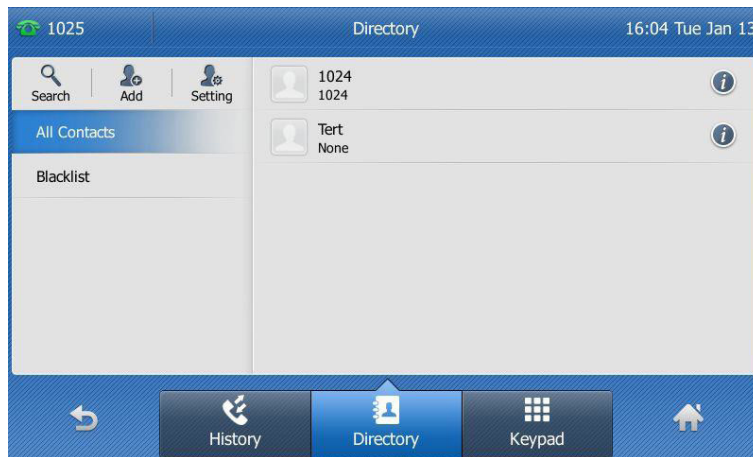
1. Tap  .
The IP phone enters the local directory directly as there is only Local Directory enabled in the directory by default.



If Local Directory is removed from the directory, tap  -> **Directory**->**All Contacts** to enter the local directory.

2. Tap  after the desired contact.
If the contact was added to a specified contact group, you can tap the contact group first, and then tap  after the desired contact.
3. Tap **Blacklist**.
The touch screen prompts the following warning:

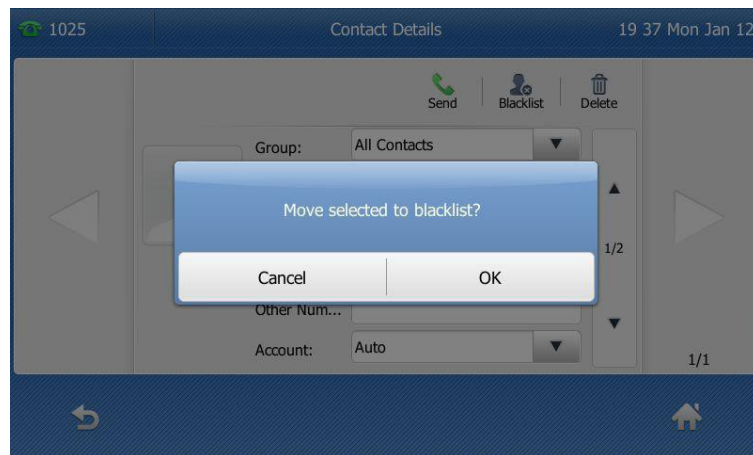

4. Tap **OK** to accept the change or **Cancel** to cancel.

Call History Management

The SIP-T48G IP phone maintains call history lists of Missed calls, Placed calls, Received calls and Forwarded calls. Call history list supports up to 400 entries. You can view call history, place a call, add a contact or delete an entry from the call history list.

History record feature is enabled by default, if you don't want to save the call history, you can disable the feature.





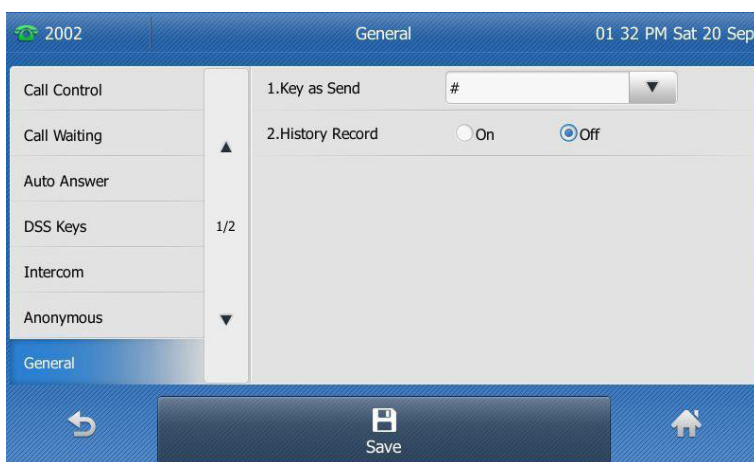

To disable history record via phone user interface:

1. Tap  ->**Features->General**.
2. Tap the **Off** radio box in the **History Record** field.





3. Tap the **Save** soft key to accept the change or  to cancel.

To view call history:

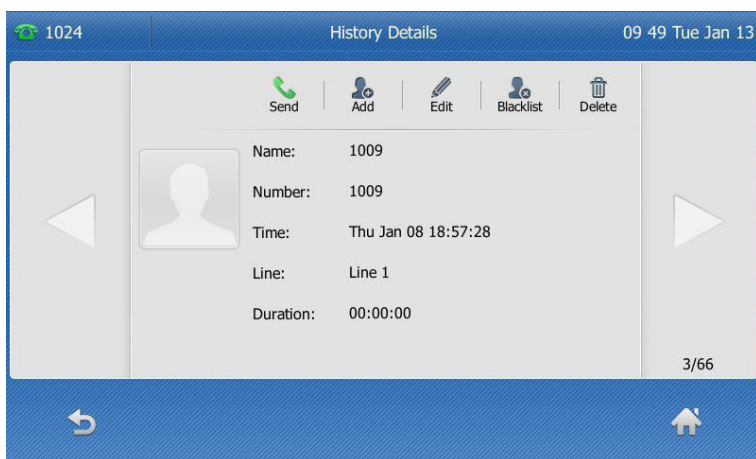
1. Tap .
The touch screen displays all call records.
2. Tap  or  to turn pages.
You can also press  or  to switch pages.
You can tap **Missed Calls**, **Placed Calls**, **Received Calls** or **Forwarded Calls** to view entries in each call list directly.
3. Tap  after the desired entry.
The detailed information of the entry appears on the touch screen.



To place a call from the call history list:

1. Tap .
The touch screen displays all call records.
2. Tap ▲ or ▼ to turn pages.
You can also press  or  to switch pages.

You can tap **Missed Calls**, **Placed Calls**, **Received Calls** or **Forwarded Calls** to view entries in each call list directly.



3. Tap the desired entry.

To add a contact to the blacklist directory from the call history list:

1. Tap .
The touch screen displays all call records.

2. Tap ▲ or ▼ to turn pages.

You can also press ⬆ or ⬇ to switch pages.

You can tap **Missed Calls**, **Placed Calls**, **Received Calls** or **Forwarded Calls** to view entries in each call list directly.

3. Tap ⓘ after the desired entry.
4. Tap **Blacklist**.

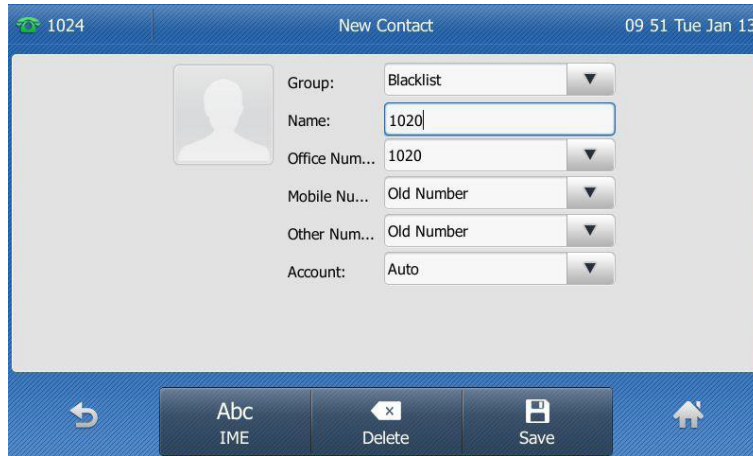

5. Enter the desired values in the corresponding fields.
6. Tap the **Save** soft key.

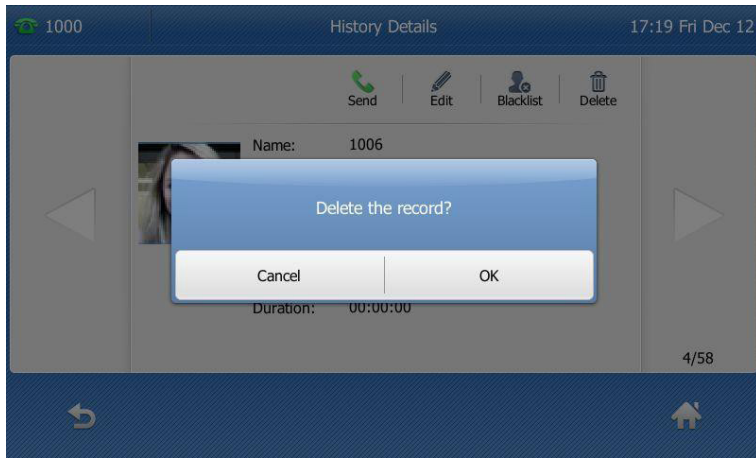

To delete an entry from the call history list:

1. Tap .
The touch screen displays all call records.
2. Tap ▲ or ▼ to turn pages.
You can also press ⬆ or ⬇ to switch pages.
You can tap **Missed Calls**, **Placed Calls**, **Received Calls** or **Forwarded Calls** to view entries in each call list directly.
3. Tap ⓘ after the desired entry.
4. Tap **Delete**.
The touch screen prompts the following warning:



5. Tap **OK** to confirm the deletion or **Cancel** to cancel.

To delete all entries from the call history list:

1. Tap . The touch screen displays all call records.
2. Tap ▲ or ▼ to turn pages.
You can also press  or  to switch pages.
You can tap **Missed Calls**, **Placed Calls**, **Received Calls** or **Forwarded Calls** to view entries in each call list directly.
3. Tap **Setting**.
4. Tap the checkbox of **Select All**.

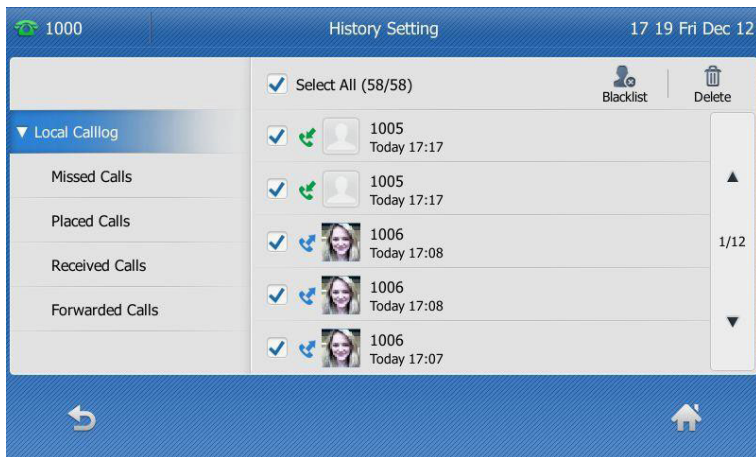

5. Tap **Delete**.
The touch screen prompts the following warning:

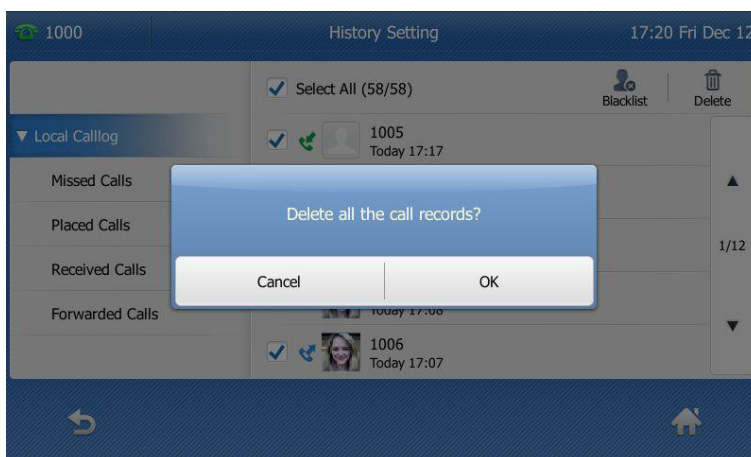

6. Tap **OK** to confirm the deletion or **Cancel** to cancel.

System Customizations

Headset Use

If you want to use a wired headset, physically connect your headset to the phone and activate the headset mode for use.

If you want to use a wireless headset, insert the Bluetooth USB dongle BT40 into the USB port on the back of the phone.

This section provides an introduction to wired headset use.

Note

If both a Bluetooth headset and a wired headset are connected, only the Bluetooth headset can be used.

Headset Mode Activation/Deactivation



To activate the headset mode:

1. Press  on the phone.

The HEADSET key LED illuminates solid green, and the icon  appears on the status bar of the touch screen when the headset mode is activated. When you tap the line key or the Answer soft key to answer an incoming call, the call is connected to your headset automatically.

With the handset on-hook, enter the desired number and tap Send, the phone will then place a call using the headset automatically.

To deactivate the headset mode:

1. Press  again on the phone.
The HEADSET key LED goes out, and the icon  disappears from the touch screen when the headset mode is deactivated.

Hotline

You can dial a hotline number immediately upon lifting the handset, pressing the Speakerphone key or tapping the line key. You can also configure a delay, and then the phone will dial out the hotline number automatically after a designated period of time.

To configure the hotline number via phone user interface:

1. Tap  -> **Features->Hot Line**.
2. Enter the desired number in the **Number** field.
3. Enter the desired delay time in the **Hotline Delay** field.
The valid values range from 0 to 10 (seconds) and the default value is "4".

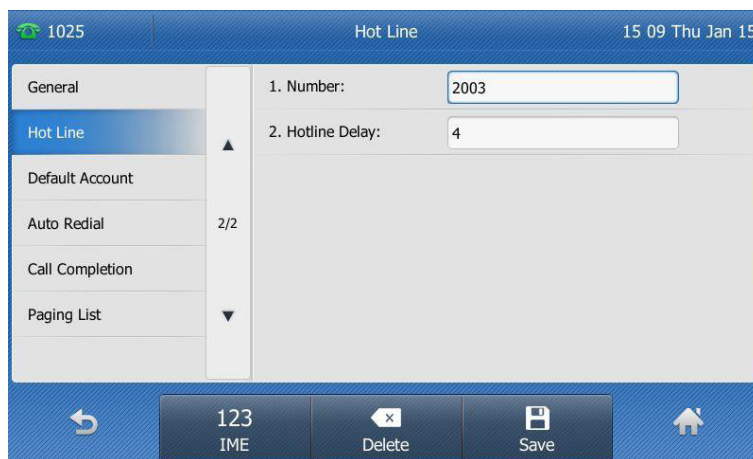

4. Tap the **Save** soft key to accept the change or  to cancel.

Hotline is configurable via web user interface at the path **Features->General Information**.

Basic Call Features

The SIP-T48G IP phone is designed to be easily used like a regular phone on a public switched telephone network (PSTN). You can place calls, answer calls, transfer a call to someone else, or conduct a conference call.

This chapter provides basic operating instructions for the SIP-T48G IP phone.

Placing Calls

You can place a call in one of three ways using your SIP-T48G IP phone:

- Using the handset
- Using the speakerphone
- Using the headset

You can also dial the number first, and then choose the way you want to speak to the other party.

You can also dial an entry/contact from call history, local directory or remote phone book.

During a call, you can alternate between Speakerphone, Headset, and Handset modes by pressing the Speakerphone key, the HEADSET key, or by picking up the handset.

The call duration of the call and far-site's information (name or phone number) are visible on the touch screen. In the figure below, the call to "Tom" (the phone number: 1056) has lasted 4 seconds.

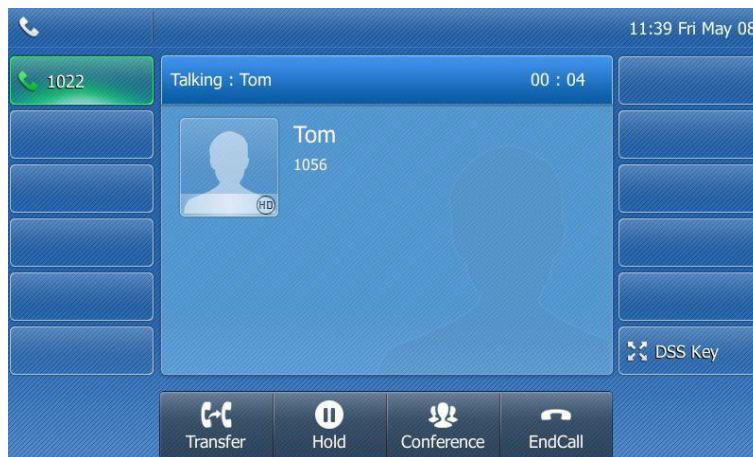

To place a call using the handset:

1. Pick up the handset.
2. Enter the desired number using the keypad.
You can enter the number using the keypad displayed on the touch screen.

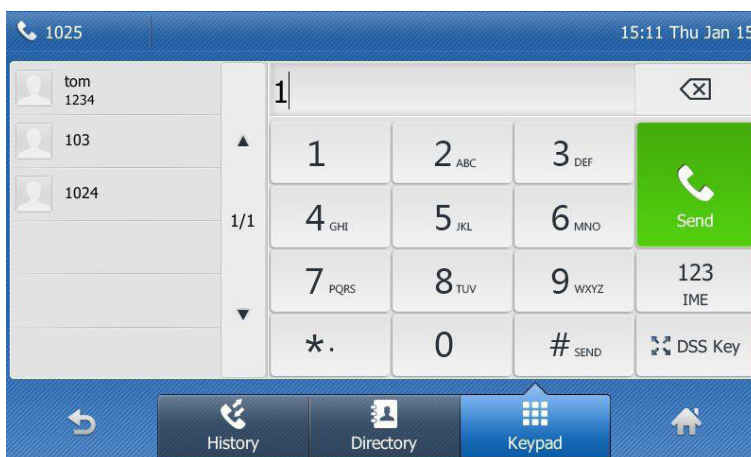







3. Press , , or tap **Send**.

The # key is configured as a send key by default

You can also tap the **History** soft key or the **Directory** soft key to search for an entry or contact after picking up the handset, and then tap the desired entry or contact to place a call.







To place a call using the hands-free speakerphone mode:

Do one of the following:

- With the handset on-hook, press  or tap the line key to obtain a dial tone.
Enter the desired number using the keypad or the on-screen keypad.
Press ,  or tap **Send**.
- With the handset on-hook, enter the desired number using the keypad.
Press , ,  or tap **Send**.

To place a call using the headset:

Do one of the following:

- With the optional headset connected, press  to activate the headset mode. Tap the line key to obtain a dial tone.
Enter the desired number using the keypad or the on-screen keypad.
Press , , or tap **Send**.
- With the optional headset connected, press  to activate the headset mode. Enter the desired number using the keypad.
Press , , or tap **Send**.

The SIP-T48G IP phone can handle multiple calls at a time. However, only one active call (the call that has audio associated with it) can be in progress at any time. The SIP-T48G IP phone can handle a maximum of 50 calls at one time.

To place multiple calls:

You can have more than one call on your SIP-T48G IP phone. To place a new call during an active call, do one of the following:

- Tap the line key. The active call is placed on hold.
Enter the desired number using the keypad or the on-screen keypad.

Press  ,  , or tap Send.

- Press  or tap the **Hold** soft key to place the original call on hold.
Tap the **NewCall** soft key.
Enter the desired number using the keypad or the on-screen keypad.

Press  ,  , or tap **Send**.

You can tap the desired call, and then tap the Resume soft key to retrieve it.

Answering Calls

When you are not in another call, you can answer a call in one of three ways:

- Using the handset
- Using the speakerphone
- Using the headset

Note

You can reject incoming calls by pressing the X key or tapping the **Reject** soft key to stop the phone from playing ring tone.

You can forward incoming calls to someone else by tapping the **FWD** soft key.

Answering When Not in Another Call

Call duration and destination will always appear on the touch screen for the active call.

To answer a call using the handset:

1. Pick up the handset.

To answer a call using the hands-free speakerphone mode:

Do one of the following:

- Press  .
- With the handset on-hook and the headset mode deactivated, tap the **Answer** soft key.
- With the handset on-hook and the headset mode deactivated, tap the line key with the illuminating solid green icon indicator.

To answer a call using the headset:

Do one of the following:

- Press .
- With the headset mode activated, tap the **Answer** soft key.
- With the headset mode activated, tap the line key with the illuminating solid green icon indicator.

Answering When in Another Call

If you have an active call, and an incoming call arrives on the phone. The incoming call information is displayed on the touch screen.







1. Press  or tap the Answer soft key.
The incoming call is answered and the original call is placed on hold.

Ending Calls

To end a call:

Do one of the following:

- If you are using the handset, press , the **EndCall** soft key or hang up the handset.
- If you are using the headset, press  or the **EndCall** soft key.
- If you are using the speakerphone, press ,  or the **EndCall** soft key.

Note

To end a call placed on hold, you can tap the **EndCall** soft key to end the call directly, or tap the Resume soft key to resume the call before ending it.

Redialing Numbers

To redial the last dialed number from your phone:

1. Press  twice.
A call to your last dialed number is attempted.

To redial a previously dialed number from your phone:

1. Press  when the phone is idle.
2. Tap the desired entry from the placed calls list.

Auto Answer

You can use auto answer feature to automatically answer an incoming call on a line. Auto answer is configurable on a per-line basis.

To configure auto answer via phone user interface:

1. Tap  -> **Features->Auto Answer**.
2. Tap the **On** radio box in the desired line.

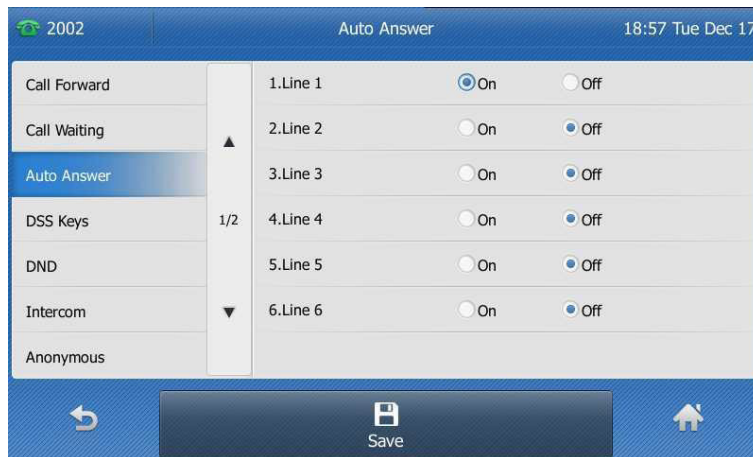

3. Tap the **Save** soft key to accept the change or  to cancel.

The  icon appears on the touch screen.



Auto answer is configurable via web user interface at the path **Account->Basic**.

Note

Auto answer is only applicable when there is no other call in progress on the phone.

Auto Redial

You can enable auto redial to automatically redial a phone number when the called party is busy. You can also configure the number of auto redial attempts and the time to wait between redial attempts.

To configure auto redial via phone user interface:

1. Tap  -> **Features->Auto Redial**.
2. Tap the On radio box in the **Auto Redial** field.
3. Enter the desired time (in seconds) in the **Redial Interval** field.
The default value is —10.
4. Enter the desired number of redial attempts in the **Redial Times** field.
The default value is —10.

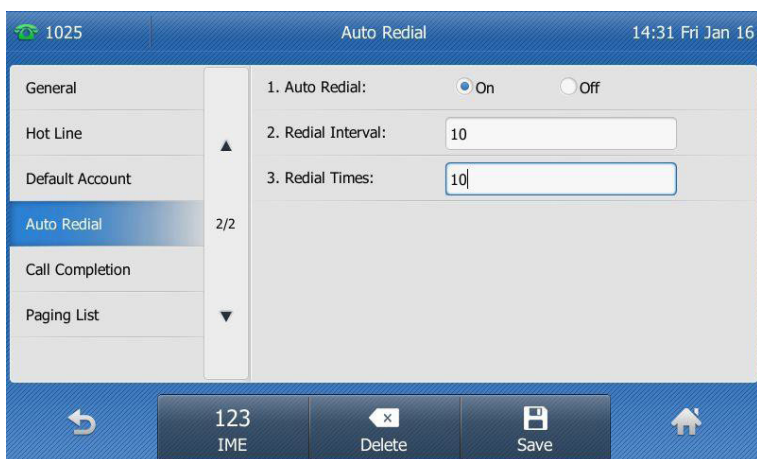

5. Tap the **Save** soft key to accept the change or  to cancel.

Auto redial is configurable via web user interface at the path **Features->General Information**.

To use auto redial:

When the called party is busy, the following prompt will appear on the touch screen of the phone:

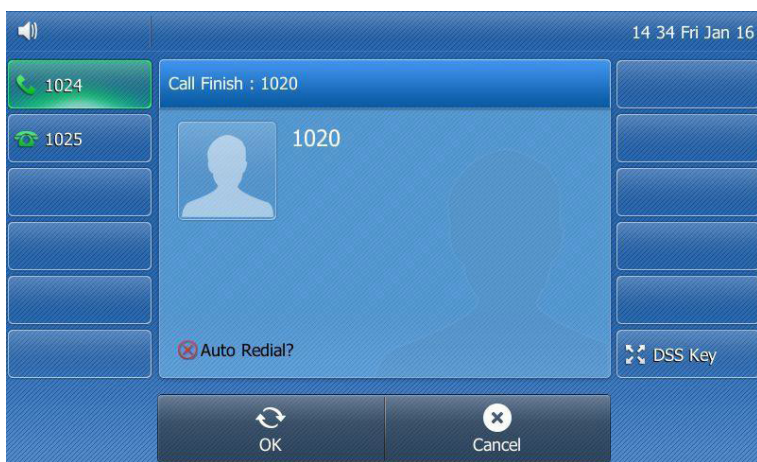

1. Tap the **OK** soft key to activate auto redial.

The touch screen prompts the following:

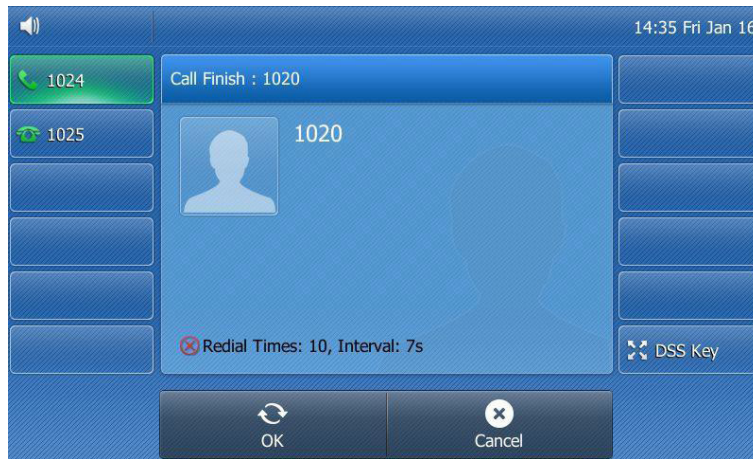

2. Wait for the designated period of time or tap the **OK** soft key to redial the phone number. The phone will retry as many times as configured until the called party is idle.

Call Mute

You can mute the microphone of the active audio device during an active call so that the other party cannot hear you. Call mute applies to all modes (Handset, Headset and Speakerphone).

To mute a call:

1. Press  during an active call. The touch screen indicates that the call is muted. The mute key LED illuminates solid red when the call is muted.

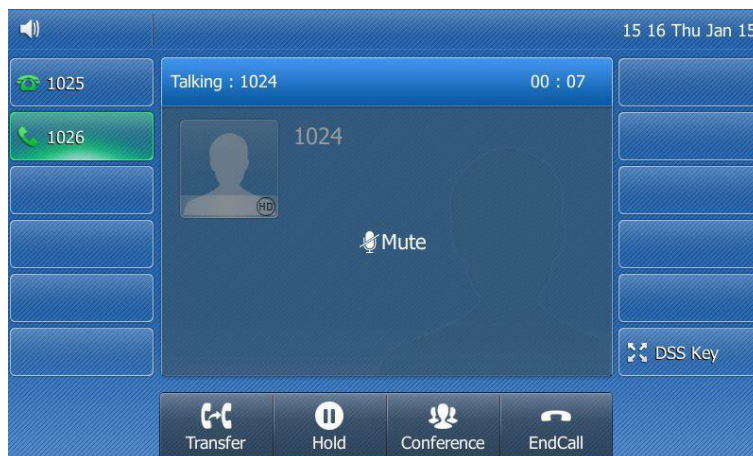

To un-mute a call:

Press  again to un-mute the call.

Call Hold/Resume

You can place an active call on hold. Only one active call can be in progress on the phone at any time. Other calls can be made and received while placing the original call on hold. When you place a call on hold, your IP PBX may play music to the other party while waiting.

To place a call on hold:

1. Press  or tap the **Hold** soft key during a call. The touch screen indicates that the call is on hold.

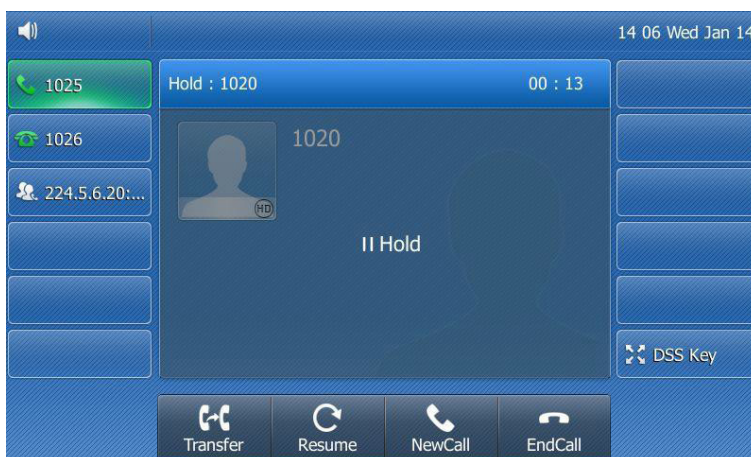

Note

The phone will beep softly every 30 seconds to remind you that you still have a call on hold.

To resume a held call:

1. Press  or tap the **Resume** soft key.

Multiple Calls on Hold:

If multiple calls are placed on hold, do one of the following:

- Tap the desired call, and then press  or tap the **Resume** soft key to retrieve it.
- Tap the desired call, and then tap the corresponding line key to retrieve it.

Do Not Disturb (DND)

You can use DND to reject incoming calls automatically on the phone. The prompt message “n New Missed Call(s)” (“n” indicates the number of missed calls) will appear on the touch screen, and callers will receive a busy message. All calls you receive while DND is enabled are logged to your missed calls list.

Note

The prompt message will display only if Missed Call Log for the line is enabled. Missed call log is configurable via web user interface at the path **Account->Basic->Missed Call Log**.

Do not disturb is local to the phone, and may be overridden by the server settings. For more information, contact your system administrator.

You can enable/disable DND for the phone system, or you can customize DND for each or all accounts. Two DND modes:

- **Phone** (default): DND is effective for the phone system.
- **Custom**: DND can be configured for each or all accounts.

You can receive incoming calls from authorized numbers when DND is enabled.

To activate DND in phone mode:

1. Tap .

The  icon on the status bar indicates that DND is enabled. Incoming calls will be rejected automatically and “n New Missed Call(s)” (“n” indicates the number of missed calls. e.g., 1 New Missed Call(s)) will appear on the touch screen.

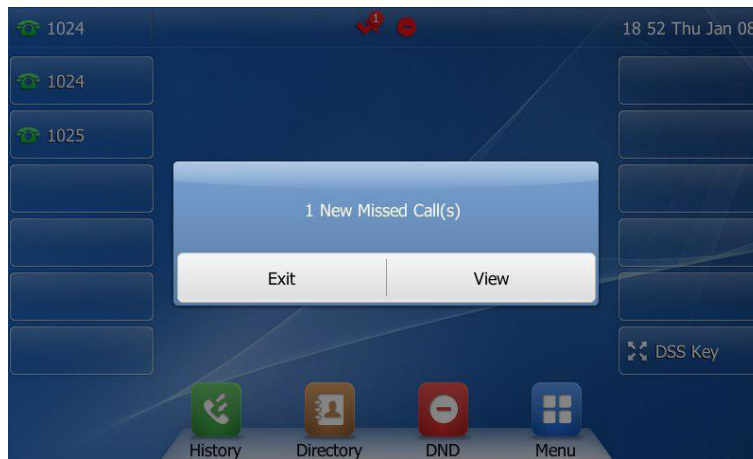

Note

When DND and busy forward are enabled in phone mode, calls will be sent to the configured destination number.

Call Forward

You can configure your phone to forward incoming calls to another party through the static forwarding. You can also forward calls while your phone is ringing; refer to [Dynamic Forwarding](#).

Static Forwarding



Three types of static forwarding:

- **Always Forward:** Incoming calls are immediately forwarded.
- **Busy Forward:** Incoming calls are immediately forwarded if the phone is busy.
- **No Answer Forward:** Incoming calls are forwarded if not answered after a period of time.

You can enable/disable call forward for the phone system, or you can customize call forward for each or all accounts. Two call forward modes:

- **Phone** (default): Call forward is effective for the phone system.
- **Custom:** Call forward can be configured for each or all accounts.

To enable call forward in phone mode:

1. Tap  -> **Features**->**Call Forward** or press  when the phone is idle.
2. Tap the desired forwarding type.
3. Depending on your selection:
 - a) If you tap **Always Forward**:
 1. Tap the **On** radio box in the **Always Forward** field.
 2. Enter the destination number you want to forward all incoming calls to in the **Forward to** field.
 3. (Optional.) Enter the always forward on code or off code respectively in the **On Code** or **Off Code** field.

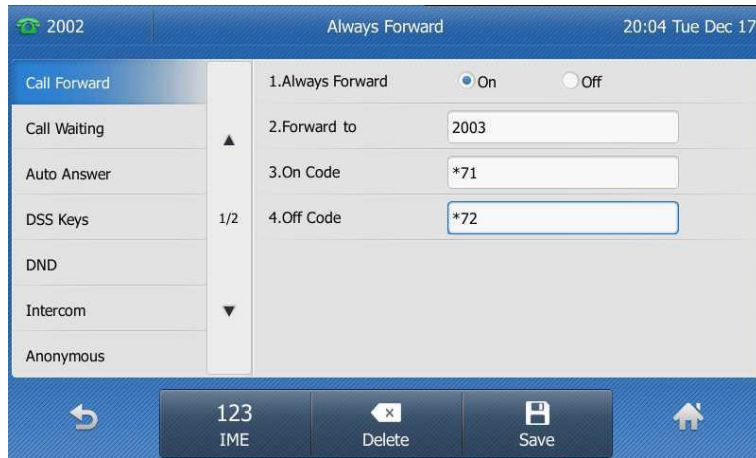

b) If you tap **Busy Forward**:

- 1) Tap the **On** radio box in the **Busy Forward** field.
- 2) Enter the destination number you want to forward incoming calls to when the phone is busy in the **Forward to** field.
- 3) (Optional.) Enter the busy forward on code or off code respectively in the **On Code** or **Off Code** field.

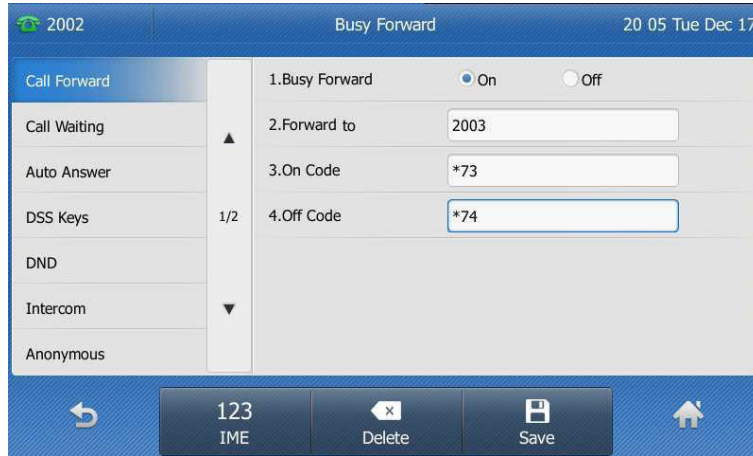

c) If you tap **No Answer Forward**:

- 1) Tap the **On** radio box in the **No Answer Forward** field.
- 2) Enter the destination number you want to forward unanswered incoming calls to in the **Forward to** field.
- 3) Tap the gray box of the **After Ring Time** field, and then select the desired ring time to wait before forwarding from the pull-down list. The default ring time is 12 seconds.
- 4) (Optional.) Enter the no answer forward on code or off code respectively in the **On Code** or **Off Code** field.

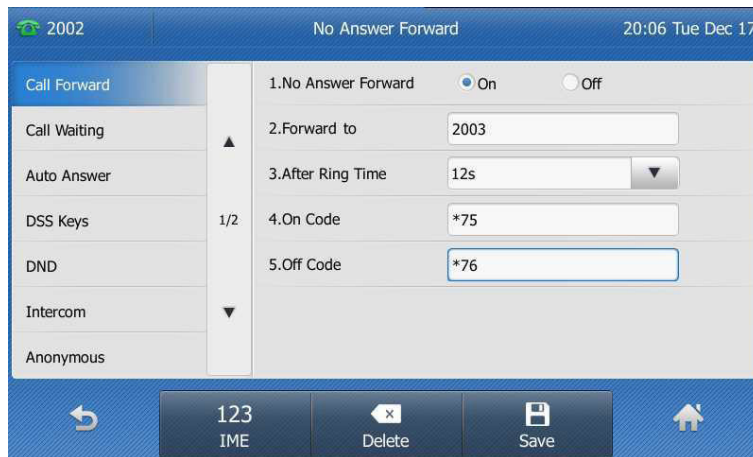



4. Tap the **Save** soft key to accept the change.



The  icon on the idle screen indicates that the call forward is enabled.

To disable call forward in phone mode:

Do one of the following:

- Press  when the phone is idle.
You can also tap the forward key to disable call forward directly if a forward key is configured.
- Tap  ->Features->Call Forward.
Tap the desired forwarding type.
Tap the **Off** radio box.
Tap the **Save** soft key to accept the change.

To disable call forward in custom mode for a specific account:

1. Tap  ->**Features->Call Forward** or press  when the phone is idle.
The touch screen displays a list of accounts registered on the phone.
2. Tap the desired account.
3. Tap the desired forwarding type.
4. Tap the **Off** radio box.
5. Tap the **Save** soft key to accept the change.

Dynamic Forwarding

To forward an incoming call to another party:

1. When the phone is ringing, tap **FWD**.

2. Enter the number you want to forward the incoming call to.

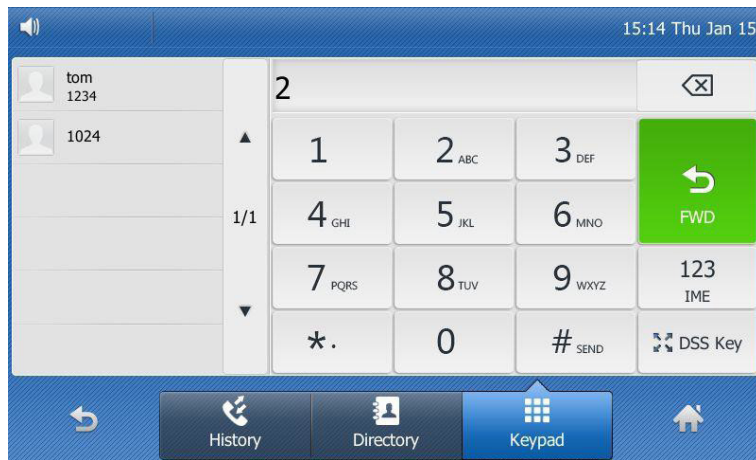

3. Press , , or tap **FWD**.

The touch screen prompts a call forward message.

Note

When the phone forwards a call, a prompt window will pop up by default, if you want to disable the feature, contact your system administrator for more information.

Call Transfer

You can transfer a call to another party in one of three ways:

- **Blind Transfer:** Transfer a call directly to another party without consulting.
- **Semi-Attended Transfer:** Transfer a call when the target phone is ringing.
- **Attended Transfer:** Transfer a call with prior consulting.





To perform a blind transfer:

1. Press  or tap the **Transfer** soft key during a call.
2. Enter the number you want to transfer the call to.



3. Press  or tap **Transfer** to complete the transfer.
The call is then connected to the number to which you are transferring.

To perform a semi-attended transfer:

1. Press  or tap the **Transfer** soft key during a call.
2. Do one of the following:
 - Enter the number you want to transfer the call to.
 - Tap the **Directory** soft key, and then tap **All Contacts**. Search for the contact and tap the desired contact to dial out.
 - Tap the **History** soft key, and then tap the desired list. Tap the desired entry to dial out.
 - Tap the **Directory** soft key, and then tap **Remote Phone Book**. Search for the contact and tap the desired contact to dial out.
3. Press  or  to dial out.
4. Press  or tap **Transfer** to complete the transfer when receiving ringback.

To perform an attended transfer:

1. Press  or tap the **Transfer** soft key during a call.
2. Do one of the following:
 - Enter the number you want to transfer the call to.
 - Tap the **Directory** soft key, and then tap **All Contacts**. Search for the contact and tap the desired contact to dial out.
 - Tap the **History** soft key, and then tap the desired list. Tap the desired entry to dial out.
 - Tap the **Directory** soft key, and then tap **Remote Phone Book**. Search for the contact and tap the desired contact to dial out.

3. Press  or  to dial out.
4. After the party answers the call, press  or tap **Transfer** to complete the transfer.
If you are using a handset, the transfer can be completed by hanging up the handset.

Call Waiting

You can enable or disable call waiting on the phone. If call waiting is enabled, you can receive another call when there is already an active call on the phone. Otherwise, another incoming call is automatically rejected by the phone with a busy message when there is an active call on the phone. You can also enable or disable the phone to play a warning tone when receiving another call.

To configure call waiting via phone user interface:

1. Tap  -> **Features**->**Call Waiting**.
2. Tap the **On** radio box in the **Call Waiting** field.
3. Tap the **On** radio box in the **Play Tone** field.
4. (Optional.) Enter the call waiting on code or off code respectively in the **On Code** or **Off Code** field.

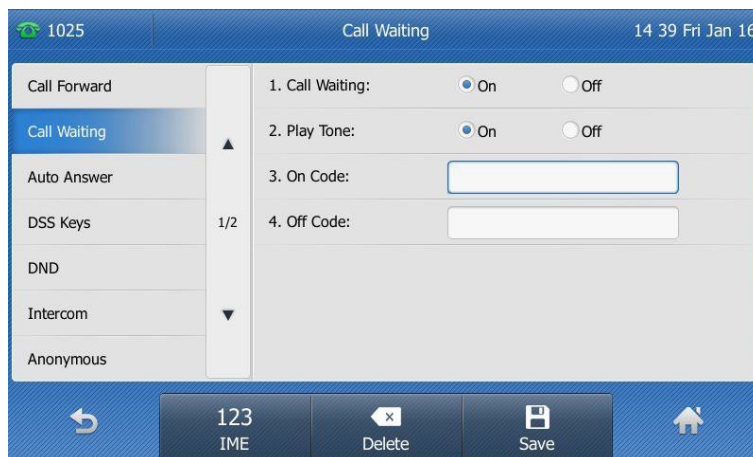

5. Tap the **Save** soft key to accept the change or  to cancel.

Call waiting is configurable via web user interface at the path **Features**->**General Information**.

Conference

You can use the SIP-T48G IP phone to create a conference with other two parties using the phone's local conference or create a conference with multiple participants which is called network conference.

Note

Network conference is not available on all servers. For more information, contact your system administrator.

Local Conference

The SIP-T48G IP phone supports up to 3 parties (including yourself) in a conference call. This is the default method of conference called Local Conference. You can create a conference between an active call and a call on hold at any time by tapping the **Conference** soft key.

To set up a local conference call:

1. Place a call to the first party.
2. When the first party answers the call, tap the **Conference** soft key to place a new call. The active call is placed on hold.
3. Enter the number of the second party, and then press **OK** , **#SEND** , or tap **Conference**.
4. When the second party answers the call, tap the **Conference** soft key again to join all parties in the conference.





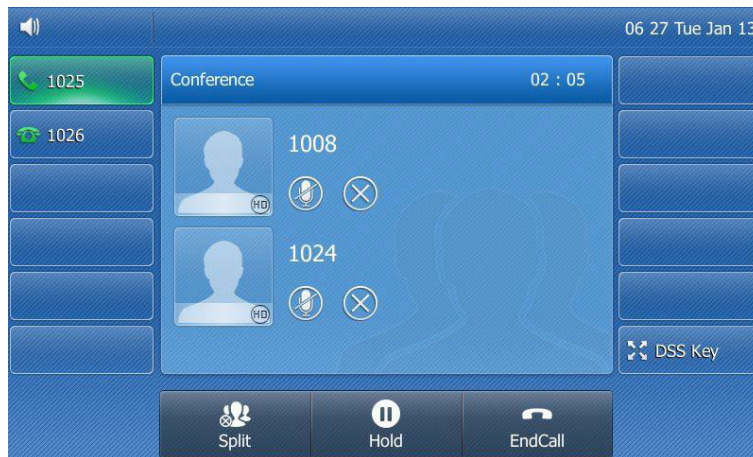

To join two calls in a conference:

1. Place two calls using two different accounts on the phone (for example, place the first call using account 1, and then place the second call using account 2).
2. Tap the desired call for conference and ensure that the call is active (for example, tap the call on account 1).
3. Tap the **Conference** soft key to join the two calls in the conference on the selected account.



During the conference call, you can do the following actions:

- Press  or tap the **Hold** soft key to place the conference call on hold.
- Tap the **Split** soft key to split the conference call into two individual calls on hold.
- Tap  to remove the desired party.
- Press  to mute the conference call, all other participants can hear each other, but they cannot hear you.
- Tap  to mute the party. The muted party can hear everyone, but no one can hear the muted party.
- Tap the **EndCall** soft key to drop the conference call.

Call Park

You can use call park feature to place a call on hold, and then retrieve the call from another phone in the system (for example, a phone in another office or conference room). You can park an active call by tapping the **Park** soft key or call park key (if configured) on the phone. If the call is parked successfully, there is a voice prompt confirming that the call was parked. You can retrieve the parked call by tapping **Retrieve** on dialing screen or retrieve park key (if configured). If the parked call is not retrieved within a period of time defined by the system, the phone performing call park will receive a call back.

Call Pickup

You can use call pickup to answer someone else's incoming call on your phone. The SIP-T48G IP phone supports directed call pickup and group call pickup. Directed call pickup is used for picking up a call that is ringing at a target phone number. Group call pickup is used for picking up a call that is ringing at any phone number in a certain group. The pickup group should be predefined, contact your system administrator for more information.

Directed Call Pickup

To pick up a call directly:

1. When a call is ringing on another phone, pick up the handset, press the Speakerphone key or press the line key.
2. To pick up the call from a specific extension, dial *95 + ext.
3. To pick up any call ringing currently on any other phone, dial *96 + ext.
4. The call is answered on your phone.

Group Call Pickup

To pick up a call in the group:

1. When a call is ringing on another phone within the group, pick up the handset, press the Speakerphone key or press the line key.
2. Dial *97
3. The call is answered on your phone.

Anonymous Call

You can use anonymous call to block your identity and phone number from appearing to the called party when you call someone. For example, you want to call to consult some of the services, but don't want to be harassed. Anonymous call is configurable on a per-line basis. You can also configure the phone to send anonymous call on/off code to the server to activate/deactivate anonymous call on the server side.

To configure anonymous call via phone user interface:

1. Tap  -> **Features->Anonymous.**
2. Tap the desired line.
3. Tap the **On** radio box in the **Local Anonymous** field.
4. (Optional.) Tap the **On Code** or **Off Code** radio box in the **Send Anony Code** field.
5. (Optional.) Enter the anonymous call on code and off code respectively in the **On Code** and **Off Code** field.

The phone will send the configured on code or off code depending on your selection when you enable or disable anonymous call feature on the phone.

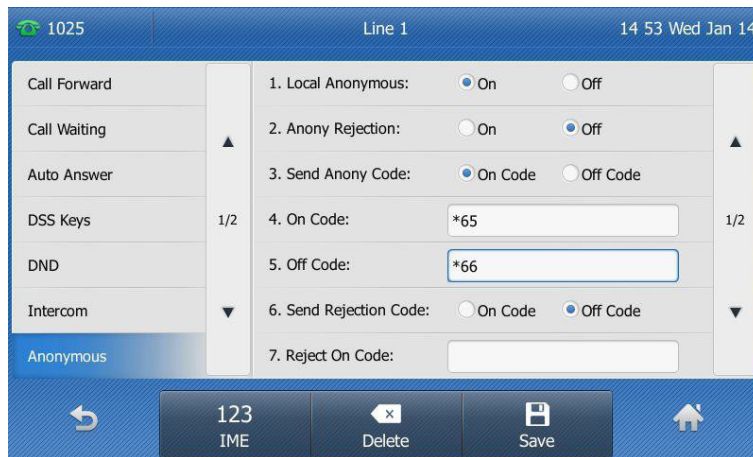

6. Tap the **Save** soft key to accept the change or  to cancel.

Anonymous call is configurable via web user interface at the path **Account->Basic**.

To place an anonymous call:

1. Using the specific line on the phone to place a call to phone B.

The touch screen of phone B prompts an incoming call from anonymity.



Anonymous Call Rejection

You can use anonymous call rejection to reject incoming calls from anonymous callers. Anonymous call rejection automatically rejects incoming calls from callers who deliberately block their identities and numbers from being displayed. Anonymous call rejection is configurable on a per-line basis. You can also configure the phone to send anonymous call rejection on/off code to the server to activate/deactivate anonymous call rejection on the server side.

To configure anonymous call rejection via phone user interface:

1. Tap  -> **Features->Anonymous**.
2. Tap the desired line.
3. Tap the **On** radio box in the **Anyony Rejection** field.
4. (Optional.) Tap the **On Code** or **Off Code** radio box in the **Send Rejection Code** field.
5. (Optional.) Enter the anonymous call rejection on code and off code respectively in the **Reject On Code** and **Reject Off Code** field.

The phone will send the configured on code or off code depending on your selection when you enable or disable local anonymous rejection feature on the phone.



6. Tap the **Save** soft key to accept the change or  to cancel.

Anonymous call rejection is configurable via web user interface at the path **Account->Basic**.

If phone B has anonymous call feature enabled and places a call to your phone, the call will be rejected, and the touch screen of the phone B will display the following:



Advanced Phone Features

This chapter provides operating instructions for the advanced features of the SIP-T48G IP phone.

Voice Mail

You can leave voice mails for someone else using the SIP-T48G IP phone. You can also listen to the voice mails that are stored in a voice mailbox. When receiving a new voice mail, the phone will play a warning tone. The power indicator LED will slow flash red, and the touch screen will prompt “n New Voice Mail(s)” (“n” indicates the number of unread voice messages, e.g., 4 New Voice Mail(s)) and an icon .

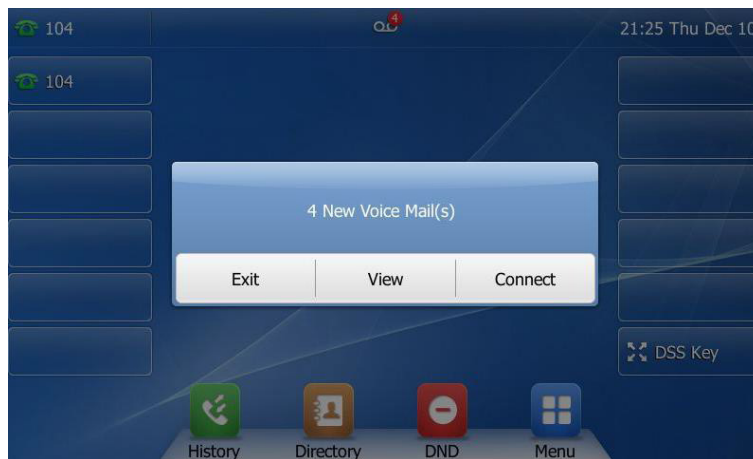

If the voice mail pop-up message box disappears, it won't pop up again unless the user receives a new voice mail or the user re-registers the account that has unread voice mail(s).

To leave a voice mail:

You can leave a voice mail for someone else when he/she is busy or inconvenient to answer the call. Follow the voice prompt from the system server to leave a voice mail, and then hang up.

To configure voice mail access codes via phone user interface:

1. Tap  -> **Message->Set Voice Mail.**
2. Enter the voice mail access code (e.g., *88) in the desired account field.

You can tap the **IME** soft key to select the proper input mode.

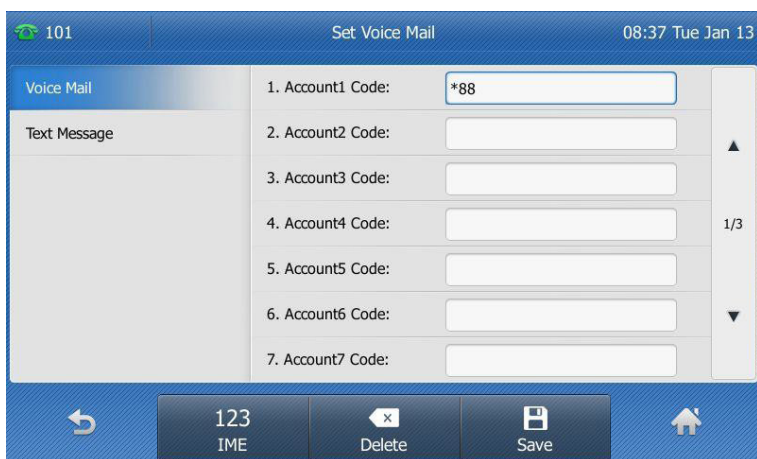

3. Tap the **Save** soft key to accept the change or  to cancel.

Note

Voice mail access codes must be predefined on the system server. Contact your system administrator for the more information.

To listen to voice mails:

1. When the touch screen prompts that the phone receives a new voice mail, you can press  or tap **Connect** to dial out the voice mail access code.
2. Follow the voice prompt to listen to your voice mails.

You can tap the  icon when the phone is idle to open the dialog box, and then tap **Connect**.

Note

Before listening to voice mails, ensure that the voice mail access code has been configured.

To view the voice mail via phone user interface:

1. Tap  -> **Message->View Voice Mail**.
The touch screen displays the amount of new and old voice mails.

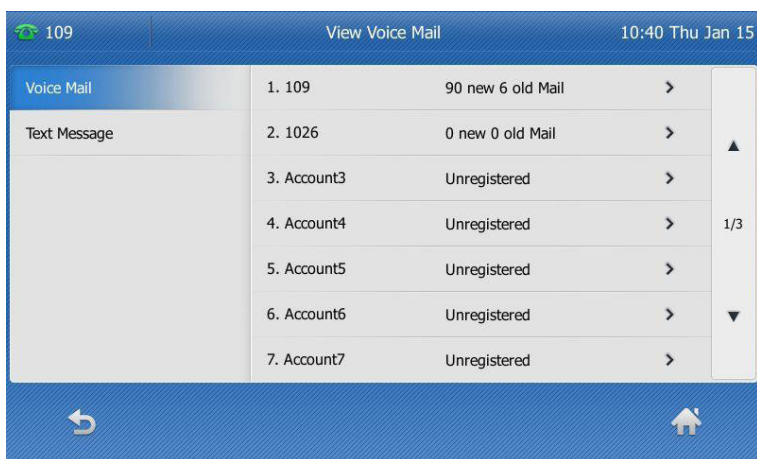

You can tap the account to listen to voice mails.

Message Waiting Indicator (MWI)

The SIP-T48G IP phone supports MWI when receiving a new voice message. If someone leaves you a voice mail, you will receive a message waiting indicator. MWI will be indicated in three ways: a warning tone, an indicator message (including a voice mail icon) on the touch screen, and the power indicator LED slow flashes red. This will be cleared when you retrieve all voice mails or delete them.

Troubleshooting

This chapter provides general troubleshooting information to help you solve the problems you might encounter when using your SIP-T48G IP phone.

If you require additional information or assistance with your new phone, contact your system administrator.

General Issues

How can I find the basic information of the IP phone?

Press the OK key when the IP phone is idle to check the basic information of the IP phone, such as IP address and firmware version.

How to obtain the MAC address of a phone when the phone is not powered on?

Three ways to obtain the MAC address of a phone:

- You can ask your supplier for the shipping information sheet which includes MAC addresses according to the corresponding PO (Purchase Order).
- You can find the MAC address on the label of carton box.
- You can also find the MAC address from the phone's bar code on the back of the phone.

Display Issues

Why is the touch screen blank?

- Ensure that the phone is properly plugged into a functional AC outlet.
- Ensure that the output of the power adapter is 5V/2A.
- Ensure that the phone is plugged into a socket controlled by a switch that is on.
- If the phone is plugged into a power strip, try to plug it directly into a wall outlet instead.
- If the phone is powered from PoE, ensure that you use a PoE-compliant switch or hub.
- Check if the IP phone enters the power-saving mode.

Why does the phone display “Network unavailable”?

- Ensure that the Ethernet cable is plugged into the Internet port on the phone and the Ethernet cable is not loose.
- Ensure that the switch or hub in your network is operational.

Why doesn't the phone display time and date correctly?

Check if you have configured the phone to obtain the time and date from the SNTP server automatically. If the phone fails to connect to the SNTP server, contact your system administrator for more information. You can also configure the time and date manually.

Call Issues

Why can't I receive calls?

- Check the SIP registration with your system administrator.
- Check that the DND (Do Not Disturb) mode is deactivated on your phone.
- Check that call forward is disabled on the phone.
- Check whether the caller number is stored in the blacklist directory.

Headset & Handset Issues

Why does my handset not work?

Check that the handset cord is fully connected to both the handset jack on the phone and handset.

Why does my headset not work?

- Check that the headset cord is properly connected to the headset jack on the phone.
- Check that the headset mode is activated.
- Check that the headset volume is adjusted to an appropriate level.

Audio Issues

Why can't I get a dial tone?

- Check for any loose connections and that the phone has been installed properly.
- Switch between the Handset, Headset (if present) or Hands-Free Speakerphone to check whether the dial tone is present for one of the audio modes.

If the dial tone exists on another audio mode, connect a different handset or headset to isolate the problem.

Why doesn't the phone ring?

Check the ringer volume on the phone. To adjust the ringer volume setting, press the Volume key when the phone is on-hook and idle.

Regulatory Notices

Service Agreements

Contact your Yealink Authorized Reseller for information about service agreements applicable to your product.

Limitations of Liability

TO THE FULL EXTENT ALLOWED BY LAW, YEALINK EXCLUDES FOR ITSELF AND ITS SUPPLIERS ANY LIABILITY, WHETHER BASED IN CONTRACT OR TORT (INCLUDING NEGLIGENCE), FOR INCIDENTAL, CONSEQUENTIAL, INDIRECT, SPECIAL, OR PUNITIVE DAMAGES OF ANY KIND, OR FOR LOSS OF REVENUE OR PROFITS, LOSS OF BUSINESS, LOSS OF INFORMATION OR DATA, OR OTHER FINANCIAL LOSS ARISING OUT OF OR IN CONNECTION WITH THE SALE, INSTALLATION, MAINTENANCE, USE, PERFORMANCE, FAILURE, OR INTERRUPTION OF ITS PRODUCTS, EVEN IF YEALINK OR ITS AUTHORIZED RESELLER HAS BEEN ADVISED OF THE POSSIBILITY OF SUCH DAMAGES, AND LIMITS ITS LIABILITY TO REPAIR, REPLACEMENT, OR REFUND OF THE PURCHASERICE PAID, AT YEALINK'S OPTION. THIS DISCLAIMER OF LIABILITY FOR DAMAGES WILL NOT BE AFFECTED IF ANY REMEDY PROVIDED HEREIN SHALL FAIL OF ITS ESSENTIAL PURPOSE.

Safety Instructions

Save these instructions. Read these safety instructions before use!

The following basic safety precautions should always be followed to reduce the risk of fire, electrical shock, and other personal injury.

General Requirements

- Before you install and use the device, read the safety instructions carefully and observe the situation during operation.
- During the process of storage, transportation, and operation, please always keep the device dry and clean.
- During the process of storage, transportation, and operation, please avoid collision and crash of the device.
- Please do not attempt to dismantle the device by yourself. In case of any discrepancy, please contact the appointed maintenance center for repair.
- Without prior written consent, no organization or individual is permitted to make any change to the structure or the safety design of the device. Yealink is under no circumstances liable to consequences or legal issues caused by such changes.
- Please refer to the relevant laws and statutes while using the device. Legal rights of others should also be respected as well.

Environmental Requirements

- Place the device at a well-ventilated place. Do not expose the device under direct sunlight.
- Keep the device dry and free of dust.
- Place the device on a stable and level platform.
- Please do not place heavy objects on the device in case of damage and deformation caused by the heavy load.
- Keep at least 10 cm between the device and the closest object for heat dissipation.
- Do not place the device on or near any inflammable or fire-vulnerable object, such as rubber-made materials.
- Keep the device away from any heat source or bare fire, such as a candle or an electric heater.
- Keep the device away from any household appliance with a strong magnetic field or electromagnetic field, such as a microwave oven or a refrigerator.

Operating Requirements

- Do not let a child operate the device without guidance.
- Do not let a child play with the device or any accessory in case of accidental swallowing.
- Please only use the accessories provided or authorized by the manufacturer.
- The power supply of the device must meet the requirements of the input voltage of the device. Please use the provided surge protection power socket only.
- Before plugging or unplugging any cable, make sure that your hands are completely dry.
- Do not spill liquid of any kind on the product or use the equipment near water, for example, near a bathtub, washbowl, kitchen sink, wet basement or near a swimming pool.
- Do not tread on, pull, or over-bend any cable in case of malfunction of the device.
- During a thunderstorm, stop using the device and disconnect it from the power supply. Unplug the power plug and the Asymmetric Digital Subscriber Line (ADSL) twisted pair (the radio frequency cable) to avoid lightning strike.
- If the device is left unused for a rather long time, disconnect it from the power supply and unplug the power plug.
- When there is smoke emitted from the device, or some abnormal noise or smell, disconnect the device from the power supply, and unplug the power plug immediately. Contact the specified maintenance center for repair.
- Do not insert any object into equipment slots that is not part of the product or auxiliary product.
- Before connecting a cable, connect the grounding cable of the device first. Do not disconnect the grounding cable until you have disconnected all other cables.

Cleaning Requirements

- Before cleaning the device, stop using it and disconnect it from the power supply.
- Use a piece of soft, dry and anti-static cloth to clean the device.
- Keep the power plug clean and dry. Using a dirty or wet power plug may lead to electric shock or other perils.

Appendix A - Time Zones

Time Zone	Time Zone Name
-11	Samoa
-10	United States-Hawaii-Aleutian, United States-Alaska-Aleutian
-9:30	French Polynesia
-9	United States-Alaska Time
-8	Canada(Vancouver, Whitehorse), Mexico(Tijuana, Mexicali), United States-Pacific Time
-7	Canada(Edmonton, Calgary), Mexico(Mazatlan, Chihuahua), United States-MST no DST, United States-Mountain Time
-6	Canada-Manitoba(Winnipeg), Chile(Easter Islands), Mexico(Mexico City, Acapulco), United States-Central Time
-5	Bahamas(Nassau), Canada(Montreal, Ottawa, Quebec), Cuba(Havana), United States-Eastern Time
-4:30	Venezuela(Caracas)
-4	Canada(Halifax, Saint John), Chile(Santiago), Paraguay(Asuncion), United Kingdom-Bermuda(Bermuda), United Kingdom(Falkland Islands), Trinidad & Tobago
-3:30	Canada-New Foundland(St. Johns)
-3	Argentina(Buenos Aires), Brazil(DST), Brazil(no DST), Denmark-Greenland(Nuuk)
-2:30	Newfoundland and Labrador
-2	Brazil(no DST)
-1	Portugal(Azores)
0	Denmark-Faroe Islands(Torshavn), GMT, Greenland, Ireland(Dublin), Morocco, Portugal(Lisboa, Porto, Funchal), Spain-Canary Islands(Las Palmas), United Kingdom(London)
+1	Albania(Tirane), Austria(Vienna), Belgium(Brussels), Caicos, Chad, Croatia(Zagreb), Czech Republic(Prague), Denmark(Kopenhagen), France(Paris), Germany(Berlin), Hungary(Budapest), Italy(Rome), Luxembourg(Luxembourg), Macedonia(Skopje), Namibia(Windhoek), Netherlands(Amsterdam), Spain(Madrid)
+2	Estonia(Tallinn), Finland(Helsinki), Gaza Strip(Gaza), Greece(Athens), Israel(Tel Aviv), Jordan(Amman), Latvia(Riga), Lebanon(Beirut), Moldova(Kishinev), Romania(Bucharest), Russia(Kaliningrad), Syria(Damascus), Turkey(Ankara), Ukraine(Kyiv, Odessa)
+3	East Africa Time, Iraq(Baghdad), Russia(Moscow)
+3:30	Iran(Teheran)
+4	Armenia(Yerevan), Azerbaijan(Baku), Georgia(Tbilisi), Kazakhstan(Aktau), Russia(Samara)
+4:30	Afghanistan(Kabul)
+5	Kazakhstan(Aqtobe), Kyrgyzstan(Bishkek), Pakistan(Islamabad), Russia(Chelyabinsk)
+5:30	India(Calcutta)

+5:45	Nepal(Katmandu)
+6	Kazakhstan(Astana, Almaty), Russia(Novosibirsk, Omsk)
+6:30	Myanmar(Naypyitaw)
+7	Russia(Krasnoyarsk), Thailand(Bangkok)
+8	Australia(Perth), China(Beijing), Russia(Irkutsk, Ulan-Ude), Singapore(Singapore)
+8:45	Eucla
+9	Japan(Tokyo), Korea(Seoul), Russia(Yakutsk, Chita)
+9:30	Australia(Adelaide), Australia(Darwin)
+10	Australia(Brisbane), Australia(Hobart), Australia(Sydney, Melbourne, Canberra), Russia(Vladivostok)
+10:30	Australia(Lord Howe Islands)
+11	New Caledonia(Noumea), Russia(Srednekolymsk Time)
+11:30	Norfolk Island
+12	New Zealand(Wellington, Auckland), Russia(Kamchatka Time)
+12:45	New Zealand(Chatham Islands)
+13	Tonga(Nukualofa)
+13:30	Chatham Islands
+14	Kiribati

